

Singer 17-1

Singer 17-2

Singer 17-3

Singer 17-4

Singer 17-5

Singer 17-6

Singer 17-7

Singer 17-8

Singer 17-9

Singer 17-10

Singer 17-11

Singer 17-12

Singer 17-13

Singer 17-14

Singer 17-15

Singer 17-16

Singer 17-17

Singer 17-18

DO NOT REMOVE
ALPHABETICAL

PRICE LIST OF PARTS

No. 17

MACHINE.

BALANCE WHEEL AT RIGHT HAND.

BED $16\frac{1}{2}$ INCHES IN LENGTH, $10\frac{1}{2}$ INCHES FROM NEEDLE TO
BASE OF ARM.

OSCILLATING SHUTTLE MECHANISM.



The Singer Manufacturing Co.

INDEX.

Bobbin Winders.		PAGE
For Bobbin Winders		35
Knee Lifters.		
For Power Table and Stand		36
“ Foot Lifter.....		37
MACHINES.		
17-1 Drop Feed at left of needle.....		4
17-2 “ “ “ right “ “		9
17-3 Wheel “ “ “ “ “ with Roller Presser		9
17-4 “ “ “ “ “ “ for stitching in ends		
of cylindrical boxes.....		10
17-5 Drop Feed, for horse boots and other concave		
or convex articles.....		11
17-12 Upper Feed, for horse boots and other concave		
or convex articles.....		28
17-6 Drop Feed up the Arm, for stitching tubular or		
cylindrical articles.....		12
17-10 Drop Feed up the Arm and reverse.....		25
17-7 2 Shuttles, Drop Feed Across Arm, gauges from		
1/4-inch to 3/4-inch.....		16
17-8 Drop Feed, alternating pressers.....		23
17-9 Wheel “ “ “ “		25
17-11 Drop “ trimming attachment, leather.....		27
17-13 “ “ up Arm, with feller for cotton and		
linen goods.....		30
17-14 Drop Feed off Arm, with feller for cotton and		
linen goods.....		31
17-15 Drop Feed for portfolios and pocket-books...		31
17-16 “ “ reversible, for portfolios and pocket-		
books.....		32
17-17 Drop Feed, special, extension to left of needle		
1 5/8 inches. for cap work.....		33
17-18 Drop Feed, throat plate and presser foot,		
special, for helmet work.....		34
Stand Parts.		
For Stand Parts.....		37

LIST OF PARTS

No. 17 Machine.

In ordering from this list, use **ONLY** the **PART** number, in the first column.

Each number always indicates the **SAME PART** in whatever list it appears, or for whatever machine.

The letters after some of the numbers indicate the style of finish only, as follows:

- A Hardened, Polished and Plated.
- B. Polished and Plated.
- C. Hardened only.
- D. Polished “
- E. Soft, not Polished.

These letters **MUST BE USED** when they appear in the list, and **AFTER** the number, as in the list.

In this series

- 1 to 1500 are Screw Numbers.
- 1501 “ 1800 “ Nut “
- 1801 “ 2000 “ Roller “
- 2001 and upward are numbers of Machine Parts.

The figures in the second column refer only to the plates illustrating the parts, and are **NOT TO BE USED** in ordering.

Parts marked with an asterisk (*) are furnished only when repairs are made at factory.

PARTS COMPLETE FOR
17-1 MACHINE.

DROP FEED AT LEFT OF NEEDLE.

No. Plate.	Name.	Each
*6001	Arm	4 50
2117 221	" Dowel Pin	01
4448	" Oil Tube for intermediate bearing	06
123E 312	" Screw	06
4288 368	" Side Cover	10
286B 237	" " Thumb Screw	08
4290	" Shaft for 3022D	1 50
4368 364	" " 144D	1 50
8005 259	" " Bushing, back	25
446C 312	" " " Set Screw	03
4449 366	" " " front	30
144D 237	" " Screw	12
2007 377	" Spool Pin	02
4370 256	Balance Wheel, heavy rim, 3-in. pulley	75
2862 364	" " " " " for 3022D	1 00
4388 256	Balance Wheel, (power) light rim, 3-in. pulley	75
448C 379	" " Set Screw	03
3013 256	" " Speed Pulley, 2-in.	15
3014 256	" " " " 2½-in.	15
451C 237	" " " " Set Screw for 3013	03
437C 237	Balance Wheel Speed Pulley Set Screw for 3014	04
6629	Base	75
317E 379	Bolt to secure machine to table	02
1524 379	" Nut	01
6055 377	" Washer	01
3022D	Clamp Stop Motion	75
256D 259	" " " Clamp Screw	30
248A 237	" " " Stop Screw	02
2020 259	" " " Washer	05
3023 250	" " " Flanged Bushing	35
2022 221	" " " Pin	01
6004	Cloth Plate with 3286, 6008 and 6009	2 00
6005 365	" " " " and 6009	1 05
6008 365	" " Bracket	35
345 379	" " " Set Screw	15
389 312	" " Screw	04
6009 368	" " Slide	15
3286 368	" " " Spring	05
233B 237	" " " Screw	02
4292 364	Crank Connecting Rod	70
*4349	" " Cap	—

No. Plate.	Name.	Each
158C 237	Crank Connecting Rod Cap Screw	03
375C 312	" " " Hinge "	12
1518 312	" " " " " Nut	04
*6002	Cylinder, 2¼-in. diam., for circular bearing throat plate	12 00
*6003	Cylinder, 2¼-in. diam., for straight bearing throat plate	12 00
4348 365	Face Plate for 600D, 2111 and 4369	50
164D 312	" " Screw	04
3082 259	Feed Cam	35
446C 312	" " Set Screw	03
3083 259	Feed Connecting Link	20
375C 312	" " " Hinge Screw	12
1518 312	" " " " " Nut	04
6010 372	Feed Dog (circular feed), cloth	55
6011 372	" " " " leather	50
6015 371	" " " " for shirt work	55
6014 372	" " (incline "), " " "	55
6016 366	" " Carrier	75
225C 379	" " Screw	03
3087 364	" Forked Connection	60
375C 312	" " " Hinge Screw	12
1518 312	" " " " " Nut	04
3039 259	" Regulator	25
58E 312	" " Hinge Screw	15
818D 379	" " Thumb Screw	10
6017 364	" Rock Shaft	80
6018 366	" " " Crank	60
6019 366	" " " " for ¼-in. stitch	60
156 379	" " " " Set Screw	05
304E 301	Needle Bar	40
4301 301	" " "	40
3045 301	" " Connecting Link	30
377C 312	" " " Hinge Screw	12
1518 312	" " " " " Nut	04
2052 374	" " " Stud	30
155C 237	" " " Set Screw	03
290E 237	" " Screw Bushing	06
2166 221	" " Thread Eyelet for 3044	01
233B 237	" " " Screw	02
4302 302	" " " Guide for 4301	10
233B 237	" " " Screw	03
4303 302	" Clamp for 4301	25
2167 221	" " " 3044	17
196 237	" " Screw for 2167 and 4303	02
6022 367	Oscillating Rock Shaft (steel) for 3052	1 00
3052 367	" " " Hinge Pin	50
1518 379	" " " " Nut	05
2170	" " " Oil Pad	01
6023 364	" Shaft	40

No.	Plate.	Name.	Each
6024	377	Oscillating Shaft Crank with 1813	50
2049	221	" " " Pin	01
1813	221	" " " Roller and Stud	20
457c	237	" " " Set Screw	02
3054	301	Presser Bar	35
2062c	301	" " " Lifter	25
689c	312	" " " Screw	08
1520	379	" " " Nut	03
5608	259	" " " Lifting Bracket	25
458c	237	" " " Set Screw	02
2308	301	" " " Spring, spiral	05
3056	301	" " " " heavy	05
2070	221	" " " Washer	01
2180	372	" " " Foot for 6010 and 6011	40
2183	372	" " " 6014 " 6015	25
190	237	" " " Screw	03
262B	812	" " " Regulating Thumb Screw	25
2196	—	Roller Presser, $\frac{1}{2}$ -in., coarse roller	95
2197	—	" " " " fine	95
2198	378	" " " 1 $\frac{1}{2}$ -in. coarse "	1 05
2199	—	" " " " fine "	1 05
1868	231	" " " with 652D and 1548 for 2196	25
1841	—	" " " " " 2197	25
1839	231	" " " 386D " " 2198	40
1869	—	" " " " " 2199	40
2203	231	" " " Arm for 2196 and 2197	15
2204	231	" " " 2198 " 2199	15
440c	231	" " " Adjusting Screw	03
1547	231	" " " " Nut	03
2206	231	" " " Bracket for 2196 and 2197	20
4282	—	" " " 2198 " 2199	20
316c	231	" " " " Screw Centre	03
1547	231	" " " " Nut	03
2205	231	" " " Lock Spring	04
176	231	" " " " Screw	03
1549	231	" " " " Nut	03
6028	217	Shuttle, high point, with 2209 and 2211	1 00
2209	217	" " " Bobbin, solid	04
2210	217	" " " " light and hardened	06
2211	217	" " " Retaining Spring	05
2212	217	" " " " Rivet, per	
		100	25
6058	—	Shuttle Body for 2211	35
*2075	—	" " " Cover	35
2076	217	" " " Hinge Pin	01
2078	217	" " " Delivery Eye Thread Guard	08
2080	217	" " " " Rivet	01
6029	367	" " " Driver and Feed Cam	75
2049	221	" " " " Pin	01
2082	217	" " " Main Spring	10

No.	Plate.	Name.	Each
398B	217	Shuttle Main Spring Screw	02
6032	367	" " " Race Ring with 6038	1 00
6031	—	" " " " for shirt work	1 00
6034	368	" " " " Cover for 6031 and 6032	15
104B	379	" " " " " Screw	04
6038	375	" " " " Thread Protector for 6032	25
787D	379	" " " " " " Screw	02
175	237	" " " " " " Screw	02
466c	217	" " " " Tension Regulating Screw	04
2086	217	" " " " " Spring	03
2090	217	" " " " " Plate	05
112	217	" " " " " " Screw	03
2102	377	Tension Disc	05
1560c	379	" " " Regulating Thumb Nut	04
4369	377	" " " Releaser	15
2269	377	" " " " Pin	01
600	379	" " " Screw Stud	10
448c	379	" " " " " Set Screw	03
2108	377	" " " Spring	03
2105	377	" " " Thread Guard	03
2107	221	Thread Guard	02
233B	237	" " " " Screw for 2107	02
2112	221	" " " Retaining Disc	05
2113	—	" " " " Dowel Pin..per 100	10
2114	221	" " " Spring	01
2115	221	" " " Stud	07
460c	237	" " " " " Set Screw	02
2111	221	" " " Retainer complete	15
3071	370	" " " Take-up Cam, steel	1 25
8012	237	" " " " " Pin	01
446c	312	" " " " " Set Screw	03
9072	259	" " " Lever with 1819	60
76D	237	" " " " " Hinge Screw	05
1819	379	" " " " " Roller and Stud	30
2124	221	" " " Spring	03
2127	221	" " " " Regulator Plate	03
233B	237	" " " " " " Screw	02
6039	372	Throat Plate (circular bearing) for 6010	50
6040	372	" " " " " " 6011	50
6041	372	" " " (straight ") " "	80
6045	371	" " " " " " 6015	30
6044	372	" " " for 6014	50
6051	—	" " " Holder for 6044	1 00
6052	—	" " " " with "	1 50
171	312	" " " " " Screw	03
401R	237	" " " Screw for 6039 and 6040	02
211	379	" " " " " 6041 " 6045	02
6058	380	Drip Pan	05

Parts of 17-1 Machine.

(FURNISHED ONLY FOR REPAIRS).

No.	Plate.	Name.	Each
3028	258	Face Plate for 413D and 2127.....	50
3029	258	" " " " 600 " ".....	50
3080	258	" " " " 2111 and 2127.....	50
6062	—	Oscillating Rock Shaft for 304c and 295c (solid).....	50
304c	379	Oscillating Rock Shaft Screw Center, front..	06
295c	379	" " " " " back.....	15
2171	—	" " " " Steel Plate.....	06
2172	—	" " " " " ".....	06
2175c	301	Presser Bar Lifter for 2063 (narrow end)....	25
2060c	301	" " " " 108E.....	25
2061c	301	" " " " 33E and 70E.....	25
108E	237	" " " " Screw for 2060c.....	04
70E	237	" " " " " 2061c.....	06
33E	237	" " " " " " (long).....	06
2063	221	" " " " Stud.....	02
3055	301	" " " " Spring (flat).....	25
3057	297	" " " " Bracket for 3055.....	25
3058	297	" " " " " " 2060c & 2175c.....	25
3059	297	" " " " " " 2061c.....	25
2069	221	" " " " Guide Pin.....	01
261D	312	Pressure Regulating Thumb Screw.....	12
413	379	Tension Screw Stud.....	10
2104	377	" Thread Guard.....	01
2106	221	Thread Eyelet for 3026 to 3029.....	01
2119	221	" Take-up Spring.....	08
2129	—	" " " 2119 with short arm for 413D.....	08
2120	221	Thread Take-up Spring 2119, with closed eyelet for 413D.....	08
2130	—	Thread Take-up Spring 2119, with short arm and closed eyelet for 413D.....	08
2121	221	Thread Take-up Spring for 2119, with offset for 413D.....	08
2122	221	Thread Take-up Spring 2120, with offset and closed eyelet for 413D.....	08
2123	221	Thread Take-up Spring for 600D.....	08
2248	221	" " " " " with closed eyelet.....	08
2125	221	Thread Take-up Spring Regulator.....	05
2126	221	" " " " " Plate.....	08
283D	237	" " " " " Screw!.....	02

PARTS SPECIAL TO

17-2 MACHINE.

DROP FEED AT RIGHT OF NEEDLE.

No.	Plate.	Name.	Each
*6001	—	Arm.....	4 50
*6002	—	Cylinder, 2½-in. diam., for circular bearing throat plate.....	12 00
*6003	—	Cylinder, 2½-in. diam., for straight bearing throat plate.....	12 00
6067	371	Feed Dog (circular feed), cloth.....	55
6068	371	" " " " leather.....	40
225	379	" " " " Screw.....	03
3044	301	Needle Bar.....	40
4301	301	" " " " " ".....	40
6069	376	Presser Foot.....	45
190	237	" " " " Screw.....	08
6070	—	Roller Presser, ¾-in., coarse roller.....	90
6071	378	" " " " fine " ".....	90
6072	—	" Arm.....	15
6073	—	" " Bracket.....	20
6074	371	Throat Plate (circular bearing) for 6067.....	50
6075	371	" " " " " " 6068.....	50
6076	371	" " (straight " ") " ".....	80
401E	237	" " " " Screw for 6074 and 6075.....	02
211	379	" " " " " 6076.....	02

For parts to complete 17-2, see 17-1 Machine.

PARTS SPECIAL TO

17-3 MACHINE.

WHEEL FEED AT RIGHT OF NEEDLE WITH ROLLER PRESSER,

No.	Plate.	Name.	Each
*6001	—	Arm.....	4 50
*6080	—	Cylinder, 2½-in. diam.....	12 00
6081	—	Cloth Plate with 3286, 6083 and 6009.....	2 15
6082	365	" " " " 6081 with 3286 and 6009.....	1 65
6083	365	" " " " Bracket.....	50
6009	368	" " " " Slide.....	15
3074	259	Feed Eccentric.....	30
446c	312	" " " " Set Screw.....	08
6085	364	" Rock Shaft.....	80
6086	367	" Wheel.....	2 00

No.	Plate.	Name.	Each
6087	366	Feed Wheel Driver.....	75
6088	375	" " Spring.....	02
207	287	" " " Screw.....	02
6089	377	" " Friction ".....	02
207	287	" " " Screw.....	02
6070	—	Roller Presser, $\frac{1}{8}$ -in., coarse roller.....	90
6071	378	" " " fine ".....	90
6072	—	" Arm.....	15
6073	—	" Bracket.....	20
3044	301	Needle Bar.....	40
4301	301	" ".....	40
2092	367	Shuttle Driver.....	50
2049	221	" " Pin.....	01
6090	367	Race and Throat Ring.....	1 75
198B	312	" " " " Screw.....	01

PARTS SPECIAL TO

17-4 MACHINE.

WHEEL FEED AT RIGHT OF NEEDLE, FOR STITCHING IN ENDS OF CYLINDRICAL BOXES.

No.	Plate.	Name.	Each
*6001	—	Arm.....	4 50
6091	369	Box Support, left.....	50
6092	369	" " right.....	50
233B	287	" " Screw.....	02
*6098	—	Cylinder, $2\frac{1}{4}$ -in. diam.....	12 00
6094	—	Feed Wheel.....	2 00
6095	367	" " with 6098.....	2 25
6096	—	" " Guard.....	25
6099	369	Guide Bracket for 6097.....	5 00
6100	369	" " " 6098.....	1 50
381D	379	" " Screw.....	06
6101	369	" Rod.....	75
6102	369	" Holder.....	50
1593	—	" " Thumb Nut.....	12
6103	377	" " Washer.....	05
296B	287	" " Thumb Screw.....	08
6104	369	" Roller.....	50
6097	—	" complete for machine, consisting of 296B, two 381D, 1593, 6099 and 6101 to 6104.....	8 00
6098	—	Guide complete for table, consisting of 296B, 1593 and 6100 to 6104.....	4 50
6105	374	Presser Foot.....	1 50
6106	367	Shuttle Race and Throat Ring.....	1 75
198B	312	" " " " Screw.....	01

For parts to complete 17-4, see 17-1 Machine.

PARTS SPECIAL TO

17-5 MACHINE.

DROP FEED FOR HORSE BOOTS AND OTHER CONCAVE OR CONVEX ARTICLES.

No.	Plate.	Name.	Each
*6001	—	Arm.....	4 50
6109	364	" Shaft for 3011.....	1 50
6107	364	" " " 5977.....	1 50
3011	256	Balance Wheel, 2 speed.....	1 75
5977	—	" " " " for loose wheel attachment.....	1 75
448c	379	Balance Wheel Set Screw.....	03
5978	366	Driving Flange.....	50
5979	377	" " Latch.....	10
136A	379	" " " Hinge Screw.....	04
435c	379	" " Set Screw.....	04
5980	377	" " Spring.....	05
330B	237	" " " Screw.....	04
5993	—	" " 5978 with 136, 330B, 5979 and 5980.....	75
*6110	—	Cylinder, $2\frac{1}{4}$ -in diam.....	12 00
6111	—	" Feed Cover.....	15
387B	237	" " " Screw.....	02
6112	371	Feed Dog.....	40
6113	366	" " Carrier.....	75
225c	379	" " Screw.....	08
6114	364	" Rock Shaft.....	80
3044	301	Needle Bar.....	40
5465	366	" ".....	40
5682	302	" Clamp with 5691 for 5465.....	35
6078	377	" " " 6079 " 3044.....	25
6079	377	" " Thread Eyelet for 6078.....	02
5691	—	" " " Guide " 5682.....	10
240	237	" " " " Screw.....	01
808	379	" " Screw.....	08
6117	374	Presser Foot.....	45
190	237	" " Screw.....	08
6118	367	Shuttle Race Ring with 6119.....	1 00
6108	370	" " " Cover.....	15
104B	379	" " " " Screw.....	04
175	237	" " " Screw.....	02
6119	375	" " " Thread Protector.....	25
767D	379	" " " " Screw.....	02
6120	371	Throat Plate for 6112.....	75
223B	312	" " " Screw.....	02

For parts to complete 17-5, see 17-1 Machine.

PARTS COMPLETE FOR
17-6 MACHINE.

DROP FEED UP THE ARM, FOR STITCHING TUBULAR OR
CYLINDRICAL ARTICLES.

No.	Plate.	Name.	Each
*6001	—	Arm.....	4 50
2117	221	" Dowel Pin.....	01
4448	—	" Oil Tube for intermediate bearing.....	—
123E	312	" Screw.....	06
4288	368	" Side Cover.....	10
286E	237	" " Thumb Screw.....	08
4290	—	" Shaft for 3022D.....	1 50
4368	364	" " " 144D.....	1 50
3005	259	" " Bushing, back.....	25
446C	312	" " " Set Screw.....	03
4449	366	" " " front.....	30
144D	237	" " Screw.....	12
2007	377	" Spool Pin.....	02
4370	256	Balance Wheel, heavy rim. 3-in. pulley.....	75
2862	364	" " " " " for 3022D.....	1 00
4388	256	Balance Wheel (power), light rim, 3-in. pulley.....	75
448C	379	" " Set Screw.....	03
3013	256	" " Speed Pulley, 2-in.....	15
3014	256	" " " " 2½-in.....	15
451C	237	" " " " Set Scr. for 3013.....	03
437C	237	" " " " " " 3014.....	04
6629	—	Base.....	75
317E	379	Bolt to secure machine to table.....	02
1524	379	" Nut.....	01
6055	377	" Washer.....	01
3022D	—	Clamp Stop Motion.....	75
256D	259	" " " Clamp Screw.....	30
248A	237	" " " Stop Screw.....	02
2020	259	" " " Washer.....	05
3023	259	" " " Flanged Bushing.....	35
2022	221	" " " " " Pin.....	01
6127	365	Cloth Plate.....	1 00
6115	365	" " for 6123 to 6124.....	1 00
401D	237	" " Screw.....	02
4292	364	Crank Connecting Rod.....	70
*4349	—	" " Cap.....	—
158C	237	" " " Screw.....	03
375C	312	" " " Hinge.....	12
1518	312	" " " " " Nut.....	04
*6126	—	Cylinder, 2½-in. diam.....	12 00
4343	365	Face Plate for 600D, 2111 and 4369.....	50
164D	312	" " Screw.....	04

No.	Plate.	Name.	Each
3032	259	Face Cam.....	35
446C	312	" " Set Screw.....	03
3033	259	" Connecting Link.....	20
375C	312	" " " Hinge Screw.....	12
1518	312	" " " " " Nut.....	04
6156	373	Feed Dog (cloth).....	35
6121	376	" " (" horse shoe).....	50
6157	373	" " (leather).....	35
185	379	" " Screw.....	02
6130	370	" " Spring.....	02
6158	370	Feed Forked Connection.....	75
375C	312	" " " Hinge Screw.....	12
1518	312	" " " " " Nut.....	04
6133	374	" " " " " Universal Joint.....	25
23C	379	" " " " " Hinge Screw.....	15
3039	259	Feed Regulator.....	25
58E	312	" " Hinge Screw.....	15
818E	379	" " Thumb.....	10
6160	366	" Rock Shaft.....	50
6167	366	" " " Arm.....	50
212E	379	" " " " Joint Screw.....	04
2117	221	" " " " Pin.....	01
453C	237	" " " " Set Screw.....	02
304C	379	" " " " Screw Centre.....	06
1513	379	" " " " " Nut.....	05
6161	364	" Rod.....	75
23C	379	" " Hinge Screw.....	15
6162	375	" " Raising Block.....	15
207	237	" " " " Screw.....	03
3044	301	Needle Bar.....	40
3045	301	" " Connecting Link.....	30
377C	312	" " " " Hinge Screw.....	12
1518	312	" " " " " Nut.....	04
2052	374	" " " Stud.....	30
155C	237	" " " " Set Screw.....	03
290E	237	" " Screw Bushing.....	06
2166	221	" " Thread Eyelet.....	01
233E	237	" " " " Screw.....	02
2167	221	" Clamp.....	17
196	237	" " Screw.....	02
6022	367	Oscillating Rock Shaft (steel) for 3052.....	1 00
3052	367	" " " Hinge Pin.....	50
1513	379	" " " " " Nut.....	05
2170	—	" " " Oil Pad.....	01
6023	364	" Shaft.....	40
6024	377	" " Crank with 1813.....	50
2049	221	" " " Pin.....	01
1813	221	" " " Roller and stud.....	20
457C	237	" " " Set Screw.....	02

No.	Plate.	Name.	Each
3054	301	Presser Bar.....	35
2062c	301	" " Lifter.....	25
689c	312	" " " Screw.....	08
1520	379	" " " Nut.....	03
5008	259	" " Lifting Bracket.....	25
458c	237	" " " Set Screw.....	02
2308	301	" " Spring (spiral).....	05
3056	301	" " " heavy.....	05
2070	221	" " " Washer.....	01
6139	374	" Foot, long shank.....	60
6140	374	" " short ".....	60
6122	376	" " long ".....	70
190	287	" " screw.....	03
262D	312	Pressure Regulating Thumb Screw.....	25
6141	378	Roller Presser, 3/4-in. coarse roller.....	1 05
6142	—	" " " fine ".....	1 05
6143	378	" " " 1 1/4-in. coarse ".....	1 20
6144	—	" " " fine ".....	1 20
1868	231	" " with 652D and 1548 for 6141.....	25
1841	—	" " " " " 6142.....	25
1839	231	" " " 386D " " " 6143.....	40
1809	—	" " " " " " 6144.....	40
6145	378	" Arm for 6141 and 6142.....	30
6146	378	" " " 6143 " 6144.....	30
440c	231	" " Adjusting Screw.....	03
1547	231	" " " " Nut.....	03
2206	231	" " Bracket for 6141 and 6143.....	20
4282	—	" " " 6143 " 6144.....	20
316c	231	" " " Screw Centre.....	03
1547	231	" " " " Nut.....	03
2205	231	" " Lock Spring.....	04
176	231	" " " " Screw.....	03
1549	231	" " " " Nut.....	03
6028	217	Shuttle, high point, with 2209 and 2211.....	1 00
2209	217	" Bobbin, solid.....	04
2210	217	" " " light and hardened.....	06
2211	217	" " Retaining Spring.....	05
2212	217	" " " " Rivet, per 100.....	25
*6658	—	Shuttle Body for 6028.....	35
2075	—	" Cover.....	35
2076	217	" " Hinge Pin.....	01
2078	217	" Delivery Eye Thread Guard.....	02
2080	217	" " " " Rivet.....	01
6147	370	" Driver.....	75
2049	221	" " Pin.....	01
2082	217	" Main Spring.....	10
398E	217	" " " Screw.....	02
6148	366	" Race Ring with 6153.....	1 25
6149	—	" " " 6148 with 6153 and 6150.....	1 50

No.	Plate.	Name.	Each
6150	366	Shuttle Race Ring Cap with 6151.....	25
6151	375	" " " " Hinge.....	05
6152	—	" " " " Rivet, per 100.....	10
7177	377	" " " " Spring.....	03
330D	237	" " " " Screw.....	03
198	312	" " " " Screw.....	01
6153	375	" " " Thread Protector.....	20
590E	379	" " " " Screw.....	02
466	217	" Tension Regulating Screw.....	04
2086	217	" " Spring.....	03
2090	217	" " " Plate.....	05
112	217	" " " Screw.....	03
2102	377	Tension Disc.....	05
1560c	379	" Regulating Thumb Nut.....	04
4369	377	" Releaser.....	15
2269	377	" " Pin.....	01
600	379	" Screw Stud.....	10
448c	379	" " " Set Screw.....	03
2103	377	" Spring.....	03
2105	377	" Thread Guard.....	03
2107	221	Thread Guard.....	02
233B	237	" " Screw for 2107.....	02
2112	221	" Retaining Disc.....	05
2113	—	" " " Dowel Pin, per 100.....	10
2114	221	" " Spring.....	01
2115	221	" " Stud.....	07
460c	237	" " " Set Screw.....	02
2111	221	" Retainer complete.....	15
3071	370	" Take-up Cam, (steel).....	1 25
3012	297	" " " Pin.....	01
446c	312	" " " Set Screw.....	03
3072	259	" " Lever with 1819.....	60
76D	237	" " " Hinge Screw.....	05
1819	379	" " " Roller and Stud.....	20
2124	221	" " Spring.....	03
2127	221	" " " Regulator Plate.....	03
233B	237	" " " " Screw.....	02
6173	373	Throat Plate, large hole for 6156.....	40
6163	—	" " small " " ".....	40
6123	376	" " large " " 6121.....	40
6124	—	" " small " " ".....	40
6174	—	" " large " " 6157.....	40
6164	373	" " small " " ".....	40
401B	237	" " " Screw.....	02

PARTS SPECIAL TO

17-7 MACHINE.**2 SHUTTLES, DROP FEED ACROSS ARM GAUGES FROM $\frac{1}{16}$ -INCH TO $\frac{3}{4}$ INCH.**

No.	Plate.	Name.	Each
*6001	—	Arm.....	4 50
2405	366	" Spool Bracket with two 2007.....	30
159	237	" " " Screw.....	03
*6181	—	Cylinder $2\frac{1}{4}$ -in. diam.....	12 00
3205	—	Face Plate with top tension bracket for 3267..	90
3206	—	" " " tension bracket complete for 3267.....	2 00
164D	312	Face Plate Screw.....	04
6182	376	Feed Dog, leather, for gauges $\frac{1}{8}$ -in. and $\frac{5}{16}$ -in.	40
225	379	" " " Screw.....	03

When ordering "Feed Dogs" for gauges $\frac{3}{16}$ -inch and above, always give the **GAUGE OF SEAM** for which the machine is adjusted.

4344	—	Needle Bar for 4345.....	50
3343	301	" " " 3345.....	45
3342	301	" " " 3346 to 3350.....	40
3344	301	" " " 3351 to 3353, 3504 to 3507 and 3627 to 3655.....	40
3214	374	Needle Bar Guide.....	25
4000	312	" " " Adjusting Screw.....	02
4345	302	Clamp $\frac{1}{16}$ to $\frac{3}{8}$ -in. gauge.....	60
		4527 to 4532 style same as 4531.	
4492	—	Needle Clamp $\frac{7}{16}$ -in. gauge.....	60
4493	—	" " " $\frac{1}{2}$ " ".....	60
4494	—	" " " $\frac{9}{16}$ " ".....	60
4495	—	" " " $\frac{5}{8}$ " ".....	60
4496	377	" " " $\frac{11}{16}$ " ".....	60
4497	—	" " " $\frac{3}{4}$ " ".....	60
		3351 to 3655 style same as 3352.	
3351	—	Needle Clamp $\frac{1}{4}$ -in gauge.....	75
3352	302	" " " $\frac{7}{16}$ " ".....	75
3353	—	" " " $\frac{15}{16}$ " ".....	75
3504	—	" " " $\frac{1}{4}$ " ".....	75
3505	—	" " " $\frac{1}{2}$ " ".....	75
3506	—	" " " $\frac{3}{4}$ " ".....	75
3507	—	" " " $\frac{15}{16}$ " ".....	75
3627	—	" " " $\frac{1}{16}$ " ".....	75
3628	—	" " " $\frac{1}{8}$ " ".....	75
3629	—	" " " $\frac{1}{4}$ " ".....	75
3630	—	" " " $\frac{3}{8}$ " ".....	75

No.	Plate.	Name.	Each
3631	—	Needle Clamp, $\frac{3}{8}$ -in. gauge.....	75
3632	—	" " " $\frac{1}{2}$ " ".....	75
3633	—	" " " $\frac{13}{16}$ " ".....	75
3634	—	" " " $\frac{3}{4}$ " ".....	75
3635	—	" " " $\frac{7}{16}$ " ".....	75
3636	—	" " " $\frac{9}{16}$ " ".....	75
3637	—	" " " $\frac{15}{16}$ " ".....	75
3638	—	" " " $\frac{3}{4}$ " ".....	75
3639	—	" " " $\frac{1}{2}$ " ".....	75
3640	—	" " " $\frac{3}{8}$ " ".....	75
3641	—	" " " $\frac{17}{32}$ " ".....	75
3642	—	" " " $\frac{3}{16}$ " ".....	75
3643	—	" " " $\frac{9}{16}$ " ".....	75
3644	—	" " " $\frac{3}{16}$ " ".....	75
3645	—	" " " $\frac{19}{32}$ " ".....	75
3646	—	" " " $\frac{3}{16}$ " ".....	75
3647	—	" " " $\frac{5}{16}$ " ".....	75
3648	—	" " " $\frac{3}{16}$ " ".....	75
3649	—	" " " $\frac{3}{16}$ " ".....	75
3650	—	" " " $\frac{3}{16}$ " ".....	75
3651	—	" " " $\frac{11}{16}$ " ".....	75
3652	—	" " " $\frac{15}{16}$ " ".....	75
3653	—	" " " $\frac{3}{16}$ " ".....	75
3654	—	" " " $\frac{3}{16}$ " ".....	75
3655	—	" " " $\frac{3}{16}$ " ".....	75
2273	—	" " Pin for 4345.....	01
196	237	" " Screw.....	02
6240	312	" " " Outside Needle.....	03
4650	312	" " Set Screw.....	01
3215	302	" " and Needle Bar Thread Eyelet..	01
578	237	" " " " " " " Scr.	02
6532	377	Oscillating Shaft Crank with 1813.....	50
3220	377	Presser Bar Spring Bracket for 3267.....	25
4530	237	" " " " " Set Screw.....	02
3354	—	" Foot, $\frac{3}{8}$ -in. gauge, short shank.....	1 00
3355	—	" " " $\frac{7}{16}$ " " ".....	1 00
3356	—	" " " $\frac{1}{2}$ " " ".....	1 00
3357	—	" " " $\frac{9}{16}$ " " ".....	1 00
3358	—	" " " $\frac{5}{8}$ " " ".....	1 00
3359	—	" " " $\frac{11}{16}$ " " ".....	1 00
3360	302	" " " $\frac{13}{16}$ " " ".....	1 00
3361	—	" " " $\frac{15}{16}$ " " ".....	1 00
3362	—	" " " $\frac{3}{8}$ " " ".....	1 00
3363	—	" " " $\frac{15}{16}$ " " ".....	1 00
3364	302	" " " " " long ".....	1 20
3365	—	" " " $\frac{5}{8}$ " " ".....	1 20
3366	—	" " " $\frac{15}{16}$ " " ".....	1 20
3367	—	" " " $\frac{7}{16}$ " " ".....	1 20
3512	—	" " " $\frac{1}{2}$ " " ".....	1 20
3513	—	" " " $\frac{3}{8}$ " " ".....	1 20

No.	Plate.	Name.	Each
3757	—	Presser Foot, $\frac{1}{8}$ -in. gauge, long shank	1 20
3368	—	“ “ $\frac{3}{8}$ “ “ for outside stays and strips (short shank)	1 50
3369	—	Presser Foot, $\frac{3}{8}$ -in. gauge, for outside stays and strips (short shank)	1 50
3514	—	Presser Foot, $\frac{1}{4}$ -in. gauge, for outside stays and strips (short shank)	1 50
3515	—	Presser Foot, $\frac{3}{8}$ -in. gauge, for outside stays and strips (short shank)	1 50
3758	302	Presser Foot, $\frac{1}{8}$ -in. gauge, for outside stays and strips (short shank)	1 50
3370	—	Presser Foot, $\frac{3}{8}$ -in. gauge, for outside stays and strips (long shank)	1 70
3371	—	Presser Foot, $\frac{3}{8}$ -in. gauge, for outside stays and strips (long shank)	1 70
3516	—	Presser Foot, $\frac{1}{4}$ -in. gauge, for outside stays and strips (long shank)	1 50
3517	—	Presser Foot, $\frac{3}{8}$ -in. gauge, for outside stays and strips (long shank)	1 70
3765	302	Presser Foot, $\frac{1}{8}$ -in. gauge, for outside stays and strips (long shank)	1 70
3372	—	Presser Foot, $\frac{1}{2}$ -in. gauge, for, inside stays (shoes)	1 50
3373	—	Presser Foot, $\frac{3}{8}$ -in. gauge, for inside stays (shoes)	1 50
3374	302	Presser Foot, $\frac{3}{8}$ -in. gauge, for inside stays (shoes)	1 50
3375	—	Presser Foot, $\frac{1}{4}$ -in. gauge, for inside stays (shoes)	1 50
3376	—	Presser Foot, $\frac{3}{8}$ -in. gauge, for inside stays (shoes)	1 50
3377	—	Presser Foot, $\frac{1}{4}$ -in. gauge, for inside stays (shoes)	1 50
3378	—	Presser Foot, $\frac{3}{8}$ -in. gauge, for inside stays (shoes)	1 50
3379	—	Presser Foot, $\frac{1}{4}$ -in. gauge, for inside stays (shoes)	1 50
3518	—	Presser Foot, $\frac{1}{4}$ -in. gauge, for inside stays (shoes)	1 50
190	237	Presser Foot Screw	03
3221	303	Roller Presser, $1\frac{1}{2}$ -in.	1 55
1854	303	“ with 634D and 1548.	80
3223	303	“ Arm	20
440c	231	“ “ Adjusting Screw	03
1547	231	“ “ “ “ Nut	03
3228	303	“ “ Bracket	20
316c	231	“ “ “ “ Screw Centre	03
1547	231	“ “ “ “ “ Nut	03
2205	231	“ “ Lock Spring	04
176	231	“ “ “ “ “ Screw	08

No.	Plate.	Name.	Each
1549	231	Roller Arm Lock Spring Screw Nut	03
3224	303	“ Needle Guard	25
207	237	“ “ “ Screw	02
3225	304	Shuttle, inside, with 2210 for gauges $\frac{1}{8}$, $\frac{3}{8}$ and $\frac{1}{4}$ to $\frac{1}{2}$ -inch	1 00
3226	—	Shuttle, inside, with 2210 and 3230 for gauges $\frac{1}{8}$, $\frac{3}{8}$ and $\frac{1}{4}$ to $\frac{1}{2}$ -inch	1 00
3380	304	Shuttle, inside, with 2210 for gauges $\frac{3}{8}$ to $\frac{1}{2}$ and $\frac{5}{8}$ to $\frac{3}{4}$ -inch	1 00
3381	—	Shuttle, inside, with 2210 and 3230 for gauges $\frac{3}{8}$ to $\frac{1}{2}$ and $\frac{5}{8}$ to $\frac{3}{4}$ -inch	1 00
3228	304	Shuttle, outside, with 2210 for gauges $\frac{1}{8}$ to $\frac{1}{2}$ -inch	1 00
3229	—	Shuttle, outside, with 2210 and 3230 for gauges $\frac{1}{8}$ to $\frac{1}{2}$ -inch	1 00
3519	—	Shuttle, outside, with 2210 for $\frac{1}{4}$ -inch gauge only	1 00
3520	304	Shuttle, outside, with 2210 for gauges $\frac{1}{4}$ to $\frac{3}{4}$ -inch	1 00
3521	—	Shuttle, outside, with 2210 and 3230 for gauges $\frac{1}{4}$ to $\frac{3}{4}$ -inch	1 00
3230	302	Shuttle Bobbin Retaining Spring for 3226, 3229, 3381 and 3521	05
3231	—	Shuttle Body, inside, for 3225	35
3232	—	“ “ “ “ 3226	35
3382	—	“ “ “ “ 3390	35
3383	—	“ “ “ “ 3381	35
3233	—	“ “ “ “ outside, “ 3227	35
3234	—	“ “ “ “ “ 3228	35
3235	—	“ “ “ “ “ 3229	35
3522	—	“ “ “ “ “ 3519	35
3523	—	“ “ “ “ “ 3520	35
3524	—	“ “ “ “ “ 3521	35
3236	—	“ Cover for 3225, 3226, 3380 and 3381	35
3237	—	“ “ “ “ 3227 to 3229 and 3519 to 3521	35
3238	302	“ Delivery Eye Thread Guard for 3225, 3226, 3380 and 3381	03
2079	217	Shuttle Delivery Eye Thread Guard for 3227 to 3229, and 3519 to 3521	03
6187	—	Shuttle Driver, $\frac{1}{8}$ -in. gauge	2 00
6188	—	“ “ “ “ “ $\frac{3}{8}$ “ “	2 00
		6189 to 6198, style same as 6191.	
6189	—	Shuttle Driver, $\frac{3}{8}$ -in. gauge	2 00
6190	—	“ “ “ “ “ $\frac{7}{8}$ “ “	2 00
6191	367	“ “ “ “ “ $\frac{1}{2}$ “ “	2 00
6192	—	“ “ “ “ “ $\frac{3}{4}$ “ “	2 00
6193	—	“ “ “ “ “ “ “ “	2 00
6194	—	“ “ “ “ “ $\frac{1}{4}$ “ “	2 00
6195	—	“ “ “ “ “ $\frac{3}{16}$ “ “	2 00

No. Plate.	Name.	Each
6196	Shuttle Driver, $\frac{1}{2}$ -in. gauge	2 00
6197	" " " "	2 00
6198	" " " "	2 00
6199 367	" " " "	2 00

6200 to 6203 and 6350 to 6377, style same as 6199.

6200	Shuttle Driver, $\frac{1}{2}$ -in. gauge	2 00
6201	" " " "	2 00
6202	" " " "	2 00
6203	" " " "	2 00
6350	" " " "	2 00
6351	" " " "	2 00
6352	" " " "	2 00
6353	" " " "	2 00
6354	" " " "	2 00
6355	" " " "	2 00
6356	" " " "	2 00
6357	" " " "	2 00
6358	" " " "	2 00
6359	" " " "	2 00
6360	" " " "	2 00
6361	" " " "	2 00
6362	" " " "	2 00
6363	" " " "	2 00
6364	" " " "	2 00
6365	" " " "	2 00
6366	" " " "	2 00
6367	" " " "	2 00
6368	" " " "	2 00
6369	" " " "	2 00
6370	" " " "	2 00
6371	" " " "	2 00
6372	" " " "	2 00
6373	" " " "	2 00
6374	" " " "	2 00
6375	" " " "	2 00
6376	" " " "	2 00
6377	" " " "	2 00
2049 221	Pin	01
6206 370	Race complete, $\frac{1}{8}$ -in. gauge	5 00
6207	" " " "	5 00
6208	" " " "	5 00
6209	" " " "	5 00
6210	" " " "	5 00
6211	" " " "	5 00
6212	" " " "	5 00
6213	" " " "	5 00
6214	" " " "	5 00
6215	" " " "	5 00
6216	" " " "	5 00

No. Plate.	Name.	Each
6217	Shuttle Race complete, $\frac{1}{8}$ -in. gauge	5 00
6218	" " " "	5 00
6219	" " " "	5 00
6220	" " " "	5 00
6221	" " " "	5 00
6222	" " " "	5 00
6378	" " " "	5 00
6379	" " " "	5 00
6380	" " " "	5 00
6381	" " " "	5 00
6382	" " " "	5 00
6383	" " " "	5 00
6384	" " " "	5 00
6385	" " " "	5 00
6386	" " " "	5 00
6387	" " " "	5 00
6388	" " " "	5 00
6389	" " " "	5 00
6390	" " " "	5 00
6391	" " " "	5 00
6392	" " " "	5 00
6393	" " " "	5 00
6394	" " " "	5 00
6395	" " " "	5 00
6396	" " " "	5 00
6397	" " " "	5 00
6398	" " " "	5 00
6399	" " " "	5 00
6400	" " " "	5 00
6401	" " " "	5 00
6402	" " " "	5 00
6403	" " " "	5 00
6404	" " " "	5 00
6405	" " " "	5 00
6297 368	Cover	15
104B 379	" Hinge Screw	04
104B 379	" Screw	04
2049 221	" Dowel Pin	01
629 379	" Hinge Screw (length from under the head $\frac{1}{8}$ -in)	04
6223 376	Shuttle Race Latch Pin	10
6224 376	" " " " Spring	03
400C 312	" " " " Screw	02
6227	" " " " Loop Separator, $\frac{1}{8}$ -in. gauge	1 00
6228	" " " " " "	1 00
6229	" " " " " "	1 00
6230	" " " " " "	1 00
6231	" " " " " "	1 00
6232	" " " " " "	1 00
6233	" " " " " "	1 00

No. Plate.	Name.	Each
6234	Shuttle Race Loop Separator, $\frac{11}{16}$ -in. gauge	50
6235 374	" " " " $\frac{3}{16}$ " " "	50
6236	" " " " $\frac{1}{4}$ " " "	50
6237	" " " " $\frac{7}{32}$ " " "	50
6238	" " " " $\frac{1}{2}$ " " "	50
6239	" " " " $\frac{1}{4}$ " " "	50
6240	" " " " $\frac{3}{4}$ " " "	50
6241	" " " " $\frac{9}{32}$ " " "	50
6242	" " " " $\frac{1}{2}$ " " "	50
6243	" " " " $\frac{5}{16}$ " " "	50
6406	" " " " $\frac{3}{16}$ " " "	50
6407	" " " " $\frac{1}{2}$ " " "	50
6408	" " " " $\frac{3}{8}$ " " "	50
6409	" " " " $\frac{3}{8}$ " " "	50
6410	" " " " $\frac{3}{8}$ " " "	50
6411	" " " " $\frac{1}{2}$ " " "	50
6412	" " " " $\frac{3}{4}$ " " "	50
6413	" " " " $\frac{7}{16}$ " " "	50
6414	" " " " $\frac{3}{8}$ " " "	50
6415	" " " " $\frac{1}{2}$ " " "	50
6416	" " " " $\frac{3}{8}$ " " "	50
6417	" " " " $\frac{1}{2}$ " " "	50
6418	" " " " $\frac{3}{8}$ " " "	50
6419	" " " " $\frac{1}{2}$ " " "	50
6420	" " " " $\frac{3}{8}$ " " "	50
6421	" " " " $\frac{9}{16}$ " " "	50
6422	" " " " $\frac{3}{8}$ " " "	50
6423	" " " " $\frac{1}{2}$ " " "	50
6424	" " " " $\frac{3}{8}$ " " "	50
6425	" " " " $\frac{1}{2}$ " " "	50
6426	" " " " $\frac{3}{8}$ " " "	50
6427	" " " " $\frac{1}{2}$ " " "	50
6428	" " " " $\frac{3}{8}$ " " "	50
6429	" " " " $\frac{1}{2}$ " " "	50
6430	" " " " $\frac{3}{8}$ " " "	50
6431	" " " " $\frac{3}{8}$ " " "	50
6432	" " " " $\frac{1}{2}$ " " "	50
6433	" " " " $\frac{3}{8}$ " " "	50
240c 237	" " " " Screw	01
738D 379	" " " " Screw	05
3241 302	" " Tension Spring for 3225, 3226, 3380 and 3381	03
2086 217	Shuttle Tension Spring for 3227 to 3229, and 3519 to 3521	03
3243 302	Shuttle Tension Spring Plate for 3225, 3226, 3380 and 3381	05
2090 217	Shuttle Tension Spring Plate for 3227 to 3229 and 3519 to 3521	05
3265 259	Tension Bracket	10
3266	" " with 330B, 2413, two each 637, 1560, 2103 and four 2102	70

No. Plate.	Name.	Each
190 237	Tension Bracket Screw	03
2413 301	" " Thread Eyelet (double)	03
330B 237	" " " " Screw	04
3287 369	" " Release Fork	25
637 287	" " Screw Stud	08
2105 377	" " Thread Guard	03
3280	Thread Take-up Cam, steel	1 25
3281 259	" " Lever with 1819	65
2410 221	" " Roller	25
2411 221	" " Stud	10
86E 237	" " " " Screw	05
448c 379	" " " " Set Screw	03
6246	Throat Plate, $\frac{1}{8}$ -in. gauge	45
6247	" " " " " "	45
401D 237	" " " " Screw	02

When ordering "Throat Plates" for sizes above $\frac{3}{4}$ -inch, always give the GAUGE OF SEAM for which the machine is adjusted.

For parts to complete 17-7, see 17-1 Machine.

PARTS SPECIAL TO

17-8 MACHINE.

DROP FEED, ALTERNATING PRESSER.

No. Plate.	Name.	Each
*6271	Arm	4 50
4359	" " Shaft for 144D	1 50
6004	Cloth Plate with 3286, 6008 and 6009	2 00
6005 365	" " 6004 with 3286 and 6009	1 65
6008 365	" " Bracket	35
345 379	" " " " Set Screw	15
389 312	" " " " Screw	04
6009 368	" " " " Slide	15
3286 368	" " " " Spring	10
233B 237	" " " " " " Screw	02
*6002	Cylinder, $\frac{2}{4}$ -in. diam., for circular bearing throat plate	12 00
4379 365	Face Plate for 600D, 2111 and 4378	75
3125 258	" " " " and 2111	75
175E 237	" " " " Screw	02
6272 371	Feed Dog	60
225 379	" " " " Screw	08
3126 259	Guide Bar	1 50
3127	" " with 2361, two 2362, 3132, 3134, 3135 and 3137	5 00

No.	Plate.	Name.	Each
8130	297	Guide Bar Driving Crank with 1863 and 8131 for 3094	75
3098c	297	Guide Bar Driving Crank Position Pin	03
1862	297	" " " " Roller (roller 1849 only)	20
3131	297	Guide Bar Driving Crank Roller Cap	05
3094	297	" " " " Wedge	10
690d	312	" " " " " Screw	05
8132	259	" " Lifting Bracket	1 50
626c	237	" " " " Guide Screw Stud	10
404d	237	" " " " " Screw	02
3054	301	Lifting Presser Bar	35
3133	259	" " " " Bracket with 1823	35
641E	237	" " " " Clamp Screw	03
1823	221	" " " " Roller and Stud	18
2358	259	" " " " Foot	30
193	237	" " " " Screw	03
3098	297	Needle Bar Connecting Link	75
175B	237	" " " " Adjusting Screw	02
2305	—	" " " " Stud	30
155c	237	" " " " Set Screw	03
2359	301	Presser Bar Lifter	26
598c	237	" " " " Screw	06
5610	259	" " Lifting Bracket	25
202	312	" " " " Hinge Screw	02
3100	301	" " Spring, spiral	05
3104	370	Thread Take-up Cam, steel	1 50
446c	312	" " " " Set Screw	03
6273	371	Throat Plate for 6272	05
401E	237	" " " " Screw	02
3134	259	Vibrating Presser Bar	45
2361	259	" " " " Hinge Bracket	50
2362	221	" " " " " Rivet	01
810d	379	" " " " " Cap Screw	02
3135	259	" " " " Lifting Bell Crank	75
810d	379	" " " " " " Hinge Cap Screw	02
3136	259	Vibrating Presser Foot	60
217	237	" " " " Screw	03
3137	259	" " " " Spring	10
337	237	" " " " " Screw	02

For parts to complete 17-8, see 17-1 Machine.

PARTS SPECIAL TO
17-9 MACHINE.
WHEEL FEED, ALTERNATING PRESSER.

No.	Plate.	Name.	Each
*6271	—	Arm	4 50
*6080	—	Cylinder, 2½-in. diam.	12 00
6274	374	Vibrating Presser Foot	60
217	237	" " " " Screw	03

For WHEEL FEED parts, see 17-3 Machine.

For ALTERNATING PRESSER parts, see 17-8 Machine.

For parts to complete 17-9, see 17-1 Machine.

PARTS SPECIAL TO
17-10 MACHINE.
DROP FEED UP THE ARM AND REVERSE.

No.	Plate.	Name.	Each
*6125	—	Arm	4 50
*6126	—	Cylinder, 2½-in. diam.	12 00
6127	365	Cloth Plate	1 00
401E	237	" " " " Screw	02
6281	376	Feed Dog, cloth	35
6282	376	" " leather	35
6283	373	" " 2 rows teeth	40
185	379	" " " " Screw	03
6158	370	" " Forked Connection	75
375c	312	" " " " Hinge Screw	12
1518	312	" " " " " Nut	04
6132	374	" " " " Universal Joint	35
23c	379	" " " " " Hinge Screw	15
5544	259	Feed Regulator Crank	25
6166	377	" " " " Pin	01
446c	312	" " " " Set Screw	03
6803	363	" " Lever	60
6809	—	" " " " with 6810	80
732B	379	" " " " Adjusting Thumb Scr.	10
1584	379	" " " " " " " " Nut	05
3146	377	Feed Regulator Lever Adjusting Thumb Scr.	
		Washer	01

No.	Plate.	Name.	Each
6810	368	Feed Regulator Lever Friction Plate.....	20
190	237	" " " " " Screw ..	03
6184	364	" " Shaft	15
6169	366	" " " Bracket.....	40
145	237	" " " " Screw.....	04
6811	368	" " Segment	35
207	237	" " " Screw.....	02
6160	366	" " Rock Shaft.....	50
6167	366	" " " Arm	50
212E	379	" " " " Joint Screw.....	04
2117	221	" " " " Pin	01
458c	237	" " " " Set Screw.....	02
304c	379	" " " " Screw Centre.....	06
1513	379	" " " " " Nut	05
6161	364	" " Rod.....	75
23c	379	" " Hinge Screw.....	15
6162	375	" " Raising Block.....	15
207	237	" " " " Screw.....	03
6278	374	Presser Foot, long shank.....	70
6279	374	" " short "	60
190	237	" " " Screw.....	08
6141	378	Roller Presser, $\frac{1}{8}$ -in., coarse roller.....	1 05
6142	—	" " " " fine "	1 05
6143	378	" " " $1\frac{1}{4}$ " coarse "	1 20
6144	—	" " " " fine "	1 20
6145	378	" " Arm for 6141 and 6142.....	30
6146	378	" " " 6143 " 6144.....	30
6147	370	Shuttle Driver	75
2049	231	" " Pin	01
6148	366	" " Race Ring with 6153	1 25
6149	—	" " " 6148 with 6153 and 6150 ..	1 50
6150	366	" " " Cap with 6151	25
6151	375	" " " " Hinge.....	05
6152	—	" " " " Rivet...per 100..	10
7177	377	" " " " Spring.....	03
330D	237	" " " " Screw.....	03
198	312	" " " " Screw.....	01
6153	375	" " " " Thread Protector	20
590	379	" " " " " Screw.....	02
6173	373	Throat Plate, large hole, for 6281.....	40
6163	—	" " " small " " "	40
6174	—	" " " large " " 6282.....	40
6164	—	" " " small " " "	40
6172	—	" " " large " " 6283.....	45
6280	373	" " " small " " "	45
401D	237	" " " Screw	02

For parts to complete 17-10, see 17-6 Machine.

PARTS SPECIAL TO

17-11 MACHINE.

DROP FEED, WITH TRIMMING ATTACHMENT, LEATHER.

No.	Name.	Each
*6284	— Arm	6 00
4359	" " Shaft.....	1 50
*6002	— Cylinder, $2\frac{1}{4}$ -in diam	12 00
3088	258 Face Plate for 600D and 2111.....	75
4380	— " " " " 2111 and 4369	75
175E	237 " " " Screw.....	02
6285	375 Feed Dog.....	60
225	379 " " Screw	03
6286	375 Knife, broad diagonal cut.....	08
6287	375 " " medium, end cut only.....	08
6288	375 " " " (shearing).....	08
6289	375 " " " and side cut	08
6290	375 " " " " " (concave) ..	08
6291	375 " " " " " (thin gauge)	08
6292	375 " narrow " " " "	08
3089	259 " Bar with 2301.....	1 50
3090	— " " " 2298, 2301, 3095 and 3096...	5 00
3092	297 " " Driving Crank with 1822 for 3094	1 00
3093	297 " " " " Position Pin.....	03
1822	221 " " " " Roller and Stud..	20
3094	297 " " " " Wedge.....	10
690D	312 " " " " Adjusting	
	Screw.....	05
4382	— Knife Bar Driving Slide.....	1 75
514c	379 " " " " Coupling Pin... ..	10
2296	375 " " " " " Bush... ..	06
468c	237 " " " " " " "	
	Set Screw.....	02
1564	— Knife Bar Driving Slide Coupling Pin Head..	05
2297	375 " " " " " Spring	02
3095	297 " " " " " with 1564, 2296 and	
	2297.....	2 00
2298	375 Knife Bar Handle	25
404D	237 " " " Screw	02
9804	297 " " Lifting Spring	02
2301	— " " Stop Pin.....	01
3109	297 " Holder.....	1 00
335	237 " " Screw.....	02
335	237 " Screw.....	02
2291	375 " " Washer.....	01
3097	301 Needle Bar, for round shank needle.....	1 00
3098	297 " " Connecting Link.....	75
175E	237 " " " " Adjusting Screw	02
2305c	— " " " Stud.....	30

No.	Plate.	Name.	Each
155	237	Needle Bar Connecting Stud Set Screw.....	03
2306	375	" " Thread Eyelet.....	02
239	237	" " " " Screw.....	02
336	237	" " Set Screw.....	02
5609	250	Presser Bar Lifting Bracket.....	30
453c	237	" " " " Set Screw.....	02
3100	301	" " Spring, spiral.....	05
2203	231	Roller Arm for 2309 and 2310.....	15
2204	231	" " " " 2311 " 2312.....	15
2313	231	" " Bracket for 2309 and 2310.....	20
2337	—	" " " " 2311 " 2312.....	20
2309	—	" Presser, $\frac{3}{8}$ -in. coarse roller.....	95
2310	378	" " " " fine ".....	95
2311	—	" " " " $1\frac{1}{4}$ " coarse ".....	1 05
2312	—	" " " " fine ".....	1 05
3104	370	Thread Take-up Cam, steel.....	1 50
446c	312	" " Set Screw.....	03
6293	375	Throat Plate with 6294 for 6285.....	1 50
6294	—	" " Cutting Bar, cuts $1\frac{3}{8}$ -in.....	35
6295	375	" " " " " " $\frac{3}{4}$ ".....	35
238	237	" " " " Screw.....	01
401E	237	" " Screw.....	02
2328	375	" " Spring Slide.....	15
2330	375	" " " " Spring.....	01
6296	375	" " " " Stop.....	10
2332	—	" " " " Rivet,	
		per 100.....	10

For parts to complete 17-11, see 17-1 Machine.

PARTS SPECIAL TO

17-12 MACHINE.

UPPER FEED FOR HORSE BOOTS AND OTHER CONCAVE OR CONVEX ARTICLES.

No.	Plate.	Name.	Each
*6801	—	Arm.....	6 00
6178	—	" Shaft for 3011.....	1 50
6179	—	" " " 5977.....	1 50
6303	368	" Side Cover.....	10
236B	237	" " Thumb Screw.....	08
3011	256	Balance Wheel, 2 speed.....	1 75
5977	—	" " " " for loose wheel attach- ment.....	1 75
448c	379	Balance Wheel Set Screw.....	03
*6177	—	Cylinder, $2\frac{1}{4}$ -in. diam.....	12 00

No.	Plate.	Name.	Each
5978	366	Driving Flange.....	50
5979	377	" " Latch.....	10
136A	379	" " " Hinge Screw.....	04
435c	379	" " Set Screw.....	04
5980	377	" " Spring.....	05
330B	237	" " " Screw.....	04
5993	—	" " 5978 with 136, two 435c, 5979 and 5980.....	75
4379	365	Face Plate for 600, 2111 and 4378.....	75
175E	237	" " Screw.....	02
6303	369	Feed Cam.....	1 25
446c	312	" " Set Screw.....	08
6304	369	" Lever.....	1 00
6305	369	" " Bracket.....	30
159A	237	" " " Screw.....	04
6306	375	" " Connecting Link.....	25
89	379	" " " " Hinge Screw.....	05
6307	—	" " Hinge Pin.....	10
620c	379	" " " Set Screw.....	02
133c	379	" " Stop Screw.....	04
1592	—	" " " " Lock Nut.....	08
6308	374	" Point.....	1 00
217	237	" " Screw.....	08
6309	369	" Regulator.....	75
2049	221	" " Pin.....	01
6310	375	" " Slide Block.....	30
6311	375	" " " " Spring.....	05
233B	237	" " " " Screw.....	02
751D	379	" " " " Screw Stud.....	08
1591	379	" " " " " Nut.....	10
6312	—	" " " " " Washer.....	03
6313	364	" Shaft.....	40
6314	369	" " Bracket (inner).....	40
6315	369	" " " (outer).....	35
161D	237	" " Screw.....	04
6316	369	" " Crank with 1813.....	50
2049	221	" " " Pin.....	01
1813	221	" " " Roller and Stud.....	20
453c	237	" " " Set Screw.....	02
3126	259	Guide Bar.....	1 50
3130	297	" " Driving Crank with 1862 and 3131.....	75
3093	297	" " " " Position Pin.....	03
1862	297	" " " " Roller (roller 1849 only).....	12
3131	297	Guide Bar Driving Crank Roller Cap.....	05
3094	297	" " " " Wedge.....	10
690D	312	" " " " " Screw.....	05
3132	259	" " Lifting Bracket.....	1 50
626c	237	" " " " Guide Screw Stud.....	10
404D	237	" " " " " Screw.....	02

No.	Plate.	Name.	Each
3054	301	Lifting Presser Bar.....	35
3133	259	" " " Bracket with 1823.....	35
641E	237	" " " " Clamp Screw.....	08
1823	221	" " " " Roller and Stud.....	18
6317	374	" " " Foot.....	35
190	237	" " " Screw.....	08
4301	301	Needle Bar.....	40
3098	297	" " " Connecting Link.....	75
175	237	" " " " Adjusting Screw.....	02
2305c	---	" " " Stud.....	30
155c	237	" " " " Set Screw.....	03
5682	302	" " " Clamp with 5691.....	45
808	379	" " " Screw.....	03
5691	---	" " " Thread Guide for 5682.....	10
2359	301	Presser Bar Lifter.....	25
598c	237	" " " " Screw.....	06
3100	301	" " " Spring.....	05
6118	367	Shuttle Race Ring.....	1 00
175	237	" " " " Screw.....	02
6119	375	" " " " Thread Protector.....	25
787D	379	" " " " " Screw.....	02
3104	370	Thread Take-up Cam, steel, for 3094.....	1 50
6318	374	Throat Plate.....	45
211	379	" " " " Screw.....	02
6319	369	Vibrating Feed Bar.....	45
2361	259	" " " " Hinge Bracket.....	50
2362	221	" " " " " Rivet.....	01
810D	379	" " " " " Cap Screw.....	02
3135	259	" " " " " Lifting Bell Crank.....	75
810D	379	" " " " " " Hinge Cap Screw.....	02

For parts to complete 17-12, see 17-1 Machine.

PARTS SPECIAL TO

17-13 MACHINE.

DROP FEED UP ARM, WITH FELLER, FOR COTTON AND LINEN GOODS.

No.	Plate.	Name.	Each
*6001	---	Arm.....	4 50
*6126	---	Cylinder, 2 $\frac{1}{4}$ -in. diam.....	12 00
6329	373	Feed Dog.....	35
185	379	" " " Screw.....	02
6322	373	Feller, $\frac{1}{8}$ -in.....	1 00
6325	373	" " $\frac{3}{8}$ ".....	1 00

No.	Plate.	Name.	Each
6323	373	Feller Folder for 6322.....	03
6326	373	" " " " 6325.....	02
6324	373	" " Tongue " 6322.....	01
6327	373	" " " " 6325.....	01
4301	301	Needle Bar.....	40
6175	373	Throat Plate, large hole.....	40
6176	---	" " " small ".....	40
401D	237	" " " Screw.....	02

For parts to complete 17-13, see 17-6 Machine.

PARTS SPECIAL TO

17-14 MACHINE.

DROP FEED OFF ARM, WITH FELLER, FOR COTTON AND LINEN GOODS.

No.	Plate.	Name.	Each
*6001	---	Arm.....	4 50
*6126	---	Cylinder, 2 $\frac{1}{4}$ -in. diam.....	12 00
6264	373	Feed Dog.....	35
185	379	" " " Screw.....	02
6265	---	Feller, $\frac{1}{8}$ -in.....	1 00
6266	373	" " " ".....	1 00
6267	---	" " Folder for 6265.....	01
6268	---	" " " " 6266.....	02
6324	373	" " Tongue " 6265.....	01
6327	373	" " " " 6266.....	01
4301	301	Needle Bar.....	40
6299	373	Throat Plate, large hole, for 6264.....	40
6270	---	" " " small " ".....	40
401D	237	" " " Screw.....	02

For parts to complete 17-14, see 17-6 Machine.

PARTS SPECIAL TO

17-15 MACHINE.

DROP FEED, FOR PORTFOLIOS AND POCKETBOOKS.

No.	Plate.	Name.	Each
*6001	---	Arm.....	4 50
*6003	---	Cylinder, 2 $\frac{1}{4}$ -in. diam.....	12 00
6006	365	Cloth Plate.....	1 50
6007	---	" " " with 6008.....	1 75

No.	Plate.	Name.	Each
6018	372	Feed Dog (incline feed)	50
225	379	" " Screw	08
6026	372	Presser Foot, $\frac{1}{4}$ -in. tread	75
6025	372	" " $\frac{3}{8}$ " "	50
190	237	" " Screw	08
6030	368	Shuttle Race Ring	1 00
6034	368	" " " Cover	15
104B	379	" " " Screw	04
175	237	" " " Screw	02
6043	372	Throat Plate for 6018	50
6049	—	" " Holder	1 00
6050	368	" " " 6049 with 6043	1 50
171	312	" " " Screw	08

For parts to complete 17-15, see 17-1 Machine.

PARTS SPECIAL TO 17-16 MACHINE.

DROP FEED, REVERSIBLE, FOR PORTFOLIOS AND POCKETBOOKS.

No.	Plate.	Name.	Each
*6125	—	Arm	4 50
*6008	—	Cylinder, $\frac{3}{4}$ -in. diam	12 00
6006	365	Cloth Plate	1 50
6007	—	" " with 6008	1 75
6300	—	Feed Dog (reversible)	50
225	379	" " Screw	08
5544	259	" Regulator Crank	25
6166	377	" " " Pin	01
446C	312	" " " Set Screw	08
6808	368	" " " Lever	60
6809	—	" " " with 6810	80
732B	379	" " " Adjusting Thumb Scr.	10
1584	379	" " " " " " " Nut	05
3146	377	" " " " " " " Washer	01
6810	368	Feed Regulator Lever Friction Plate	20
190	237	" " " " " " " Screw	08
6134	364	" " " " " " " Shaft	15
6169	366	" " " " " " " Bracket	40
145	237	" " " " " " " Screw	04
6811	368	" " " " " " " Segment	35
207	237	" " " " " " " Screw	02
6026	372	Presser Foot, $\frac{1}{4}$ -in. tread	75
6025	372	" " " $\frac{3}{8}$ " "	50
190	237	" " " Screw	08

No.	Plate.	Name.	Each
6030	368	Shuttle Race Ring	1 00
6034	368	" " " Cover	15
104B	379	" " " " " Screw	04
175	237	" " " " " Screw	02
6043	372	Throat Plate for 6300	50
6049	—	" " " Holder	1 00
6050	368	" " " " 6049 with 6043	1 50
171	312	" " " " " Screw	08

For parts to complete 17-16, see 17-1 Machine.

PARTS SPECIAL TO 17-17 MACHINE.

DROP FEED, SPECIAL, EXTENSION TO LEFT OF NEEDLE
 $1\frac{1}{8}$ INCHES, FOR CAP WORK.

No.	Plate.	Name.	Each
*6001	—	Arm	4 50
*6003	—	Cylinder, $\frac{3}{4}$ -in. diam	12 00
6012	372	Feed Dog (incline feed)	55
225	379	" " " Screw	08
2188	372	Presser Foot	25
190	237	" " " Screw	04
6033	368	Shuttle Race Ring with 6036 and two 6037	1 00
6034	368	" " " " " Cover	15
104B	379	" " " " " Screw	04
6036	375	" " " " " Feed Plate	10
6037	—	" " " " " " " Rivet...per 100	10
175	237	" " " " " " " Screw	02
6042	372	Throat Plate for 6012	50
6046	—	" " " " " Holder	1 00
6047	368	" " " " " 6046 with 6042	1 50
6048	368	" " " " " Extension	25
401D	237	" " " " " " " Screw	02
171	312	" " " " " " " Screw	08

For parts to complete 17-17, see 17-1 Machine.

PARTS SPECIAL TO
17-18 MACHINE.

DROP FEED, THROAT PLATE AND PRESSER FOOT, SPECIAL,
FOR HELMET WORK.

No.	Plate.	Name.	Each
*6001	—	Arm	4 50
6109	364	“ Shaft for 8011.....	1 50
6107	364	“ “ “ 5977.....	1 50
3011	256	Balance Wheel, 2-speed.....	1 75
5977	—	“ “ “ for loose wheel attach- ment.....	1 75
448c	379	Balance Wheel Set Screw	03
5978	366	Driving Flange.....	50
5979	377	“ “ Latch.....	10
136A	379	“ “ Hinge Screw.....	04
435c	379	“ “ Set Screw	04
5980	377	“ “ Spring.....	05
330B	287	“ “ Screw.....	04
5993	—	“ “ 5978 with 136, 330B, 5979 and 5980.....	75
*6484	—	Cylinder, 2½-in. diam.....	12 00
6435	376	Feed Dog (leather).....	60
225	379	“ “ Screw.....	03
3044	301	Needle Bar.....	40
5465	366	“ “	40
5682	302	“ Clamp with 5691 for 5465.....	45
6078	377	“ “ “ 6179 “ 8044.....	25
6079	377	“ “ Thread Eyelet for 6078.....	03
5691	—	“ “ Guide “ 5682.....	10
240	287	“ “ “ Screw.....	01
808	379	“ “ Screw.....	03
6436	370	Oil Cup with Eyelets.....	25
6437	—	“ “ Thread Eyelet.....	02
2180	372	Presser Foot.....	40

For Roller Presser Parts, see 17-1 Machine.

6082	367	Shuttle Race Ring with 6088.....	1 00
6084	368	“ “ “ Cover.....	15
6088	375	“ “ “ Thread Protector.....	25
767D	379	“ “ “ “ Screw	02
175	287	“ “ “ Screw.....	02
6488	376	Throat Plate.....	1 25
401D	287	“ “ Screw.....	02

For parts to complete 17-18, see 17-1 Machine.

BOBBIN WINDERS.

Bobbin Winder (tight wheel), for 17-1 to 17-4,
17-6 to 17-11 and 17-13 to 17-17 Machines.

No.	Plate.	Name.	Each
5523	310	Bobbin Winder Frame.....	10
2460	310	“ “ Friction Ring (rubber).....	02
2461	310	“ “ Pulley.....	08
2462	310	“ “ Spindle.....	12
2463	—	“ “ “ with 2461.....	20
2464	310	“ “ Spring.....	05
5521	310	“ “ complete.....	30
46D	287	“ “ Hinge Screw.....	06

Bobbin Winder (tight wheel), for 17-5, 17-12
and 17-18 Machines.

5524	310	Bobbin Winder Stand.....	15
161D	287	“ “ “ Screw.....	04
5523	—	“ “ complete with 5524.....	45
46D	287	“ “ Hinge Screw.....	06

Other parts of 5523 same as for 5521.

Bobbin Winder (loose wheel), for 17-1 to 17-4,
17-6 to 17-11 and 17-13 to 17-17 Machines.

2466	310	Bobbin Winder Eccentric.....	15
286B	287	“ “ “ Thumb Screw.....	03
5526	310	“ “ Frame.....	25
2461	310	“ “ Pulley.....	08
2468	310	“ “ Spindle.....	12
2469	310	“ “ “ with 2461.....	20
5525	310	“ “ (eccentric), complete.....	50
145	287	“ “ Screw.....	04

Bobbin Winder (loose wheel, Hamburg) for
17-1 to 17-4, 17-6 to 17-11 and 17-13
to 17-17 Machines.

2466	310	Bobbin Winder Eccentric.....	15
2708	310	“ “ “ Collar.....	03
286B	287	“ “ “ Thumb Screw.....	03
5526	310	“ “ Frame.....	15
2461	310	“ “ Pulley.....	08
2690	310	“ “ Spindle.....	25
2691	—	“ “ “ with 2461.....	30
5527	310	“ “ (eccentric) complete.....	70
145	287	“ “ Screw.....	04

PARTS COMPLETE FOR
KNEE LIFTER.

POWER TABLE AND FOOT POWER FOR STAND.

No.	Plate.	Name.	Each
6347	380	Lifting Lever.....	25
6443	—	“ “ for 17-12 Machine.....	—
802D	379	“ “ Hinge Screw.....	12
6444	—	“ “ Pin for 6443.....	—
6349	380	“ “ Spring.....	05
5608	259	Presser Bar Lifting Bracket for 17-1 to 17-7, 17-10 and 17-13 to 17-18 Machines.....	25
5610	259	Presser Bar Lifting Bracket for 17-8, 17-9 and 17-12 Machines.....	25
5609	259	Presser Bar Lifting Bracket for 17-11 Machine	25
202	237	“ “ “ Hinge Scr. for 5610	02
453C	237	“ “ “ “ Set Screw.....	02
6333	380	Pitman.....	05
2763	380	Rock Shaft.....	10
6334	380	“ “ Hanger.....	10
6335	—	“ “ Kneec Arm.....	10
6336	380	“ “ “ “ 6335 with 2766 and 2767	40
2766	—	“ “ “ “ Hub.....	15
356C	312	“ “ “ “ Set Screw.....	06
2767	—	“ “ “ Plate.....	18
356C	312	“ “ “ “ Set Screw.....	06
6337	380	“ “ Lifting Bracket.....	20
6338	380	“ “ “ “ Hook.....	15
356C	312	“ “ “ “ Set Screw.....	06
2770	380	“ “ Stop Dog.....	12
356C	312	“ “ “ “ Set Screw.....	06
6339	380	“ “ complete, consisting of 2770, 2763, 6336, 6337, 6338 and two 6334.....	1 10
6330	—	Knee Lifter complete, for 17-1 to 17-7, 17-10 and 17-13 to 17-18 Machines, consisting of 802D, 5608, 6333, 6339, 6347 and 6349.....	1 75
6331	—	Knee Lifter complete for 17-8 and 17-9 Ma- chines, consisting of 202, 802D, 5610, 6333, 6339, 6347 and 6349.....	1 75
6332	—	Knee Lifter complete for 17-11 Machine, con- sisting of 802D, 5609, 6333, 6339, 6347 and 6349.....	1 75
6445	—	Knee Lifter complete, for 17-12 Machine, con- sisting of 202, 802D, 5610, 6333, 6339, 6349, 6443 and 6444.....	1 75

PARTS SPECIAL TO
FOOT LIFTER.

POWER TABLE.

No.	Plate.	Name.	Each
5667	—	Foot Lever.....	15
5669	—	“ “ Bracket.....	10
6439	—	“ “ Chain, length 39 inches.....	15
5671	—	“ “ Hinge Pin.....	01
5672	380	“ “ Lifting Spring.....	03
5668	380	“ “ 5667 with 5669 and 5671.....	40
6344	—	“ Lifter complete, for 17-1 to 17-7, 17-10 to and 17-13 to 17-18 Machines, consisting of 802D, 5608, 6347, 6349, 5668, 5672 and 6439	1 15
6345	—	Foot Lifter complete, for 17-8 and 17-9 Ma- chines, consisting of 202, 802D, 5610, 6347, 6349, 5668, 5672 and 6439.....	1 15
6346	—	Foot Lifter complete, for 17-11 Machines, con- sisting of 802D, 5609, 6347, 6349, 5668, 5672 and 6439.....	1 15
7446	—	Foot Lifter complete, for 17-12 Machine, con- sisting of 202, 802D, 5610, 6349, 5668, 5672, 6439, 6443 and 6444.....	1 15

STAND PARTS.

25005	381	Band Wheel, 12½-in., with 25010.....	1 10
25010	381	“ “ Crank.....	15
2117	221	“ “ “ Pin.....	01
25021	—	Belt, size, ¼-in., length, 67-in., with 25127.....	20
25022	—	“ “ “ “ 70½ “ “ “.....	20
25127	—	“ Hook.....	01
25040	381	Brace.....	1 70
506	—	“ Bolt.....	03
1510	—	“ “ Nut.....	01
297C	—	“ Screw Centre.....	10
1507	—	“ “ “ Nut.....	04
25065	381	Leg.....	1 50
25074	381	Pitman (adjustable).....	25
25123	—	“ Adjusting Block.....	02
558E	—	“ “ “ Screw.....	03
1570	—	“ “ “ Nut.....	01
25075	—	“ “ “ “ Washer.....	01
17958	—	“ Stud Pin.....	01
11742	—	“ Washer.....	01

No.	Plate.	Name.	Each
25077	881	Table Support.....	20
504	—	“ “ Bolt.....	03
1510	—	“ “ Nut.....	01
25082	381	Treadle.....	65
2970	—	“ Screw Centre.....	10
1507	—	“ “ Nut.....	04
25213	—	Stand complete, 67-in. belt (table not included) 17-1 to 17-4, 17-6 to 17-11 and 17-13 to 17-17 Machines.....	7 42
25214	—	Stand complete, for 17-5, 17-12 and 17-18 Ma- chines, 70½-in. belt, otherwise same as 25213	7 42

The Singer Manufacturing Co. use and recommend exclusively
the WILLIMANTIC SPOOL COTTON.

August 31, 1896.

Errata to Form 7282.

PAGE No.

- 5 818D Price is 12c., instead of 10c.
- 11 5682 “ “ 45c., “ “ 35c.
- 11 6079 “ “ 03c., “ “ 02c.
- 12 4448 “ “ 06c.
- 13 3032 Erase “Face” and substitute “Feed.”
- 13 818B Should be “D,” instead of “B,” and price is 12c., in-
stead of 10c.
- 13 207 Price is 02c., instead of 03c.
- 14 2078 “ “ 03c., “ “ 02c.
- 18 3516 “ “ \$1.70, “ “ \$1.50.
- 24 1862 “ “ 12c., “ “ 20c.
- 25 185 “ “ 02c., “ “ 03c.
- 26 207 “ “ 02c., “ “ 03c.
- 27 3090 Erase “3090” from number column, and substitute
“4581;” also erase “3096,” and substitute “3109.”
- 27 4382 Erase “4382” and substitute “4739.”
- 27 9804 Price is 05c., instead of 02c.
- 28 5609 “ “ 25c., “ “ 30c.
- 29 6313 “ “ 75c., “ “ 40c.
- 30 6317 “ “ 60c., “ “ 35c.
- 31 6267 “ “ 02c., “ “ 01c.
- 32 6026 Erase “ $\frac{1}{8}$ ” and substitute “ $\frac{1}{3}$ ” in two places.
- 33 190 Price is 03c., instead of 04c.
- 35 2469 Erase “310.” Part is not illustrated.
- 35 5526 Price is 15c., instead of 25c.
- 36 6443 “ “ 25c.
- 36 6444 “ “ 10c.
- 36 6334 “ “ 08c., instead of 10c.
- 36 6445 “ “ \$1.85 “ “ \$1.75.
- 37 6439 “ “ 20c., “ “ 15c.
- 37 6344 After 17-10 erase “to.”
- 37 6346 “Machines” should be “Machine.”
- 37 7446 Erase “7446” and substitute “6446,” and price is
\$1.25, instead of \$1.15.
- 38 Between “1507 and 25213” add “25086, plate 381.”
Wrench, 10c.

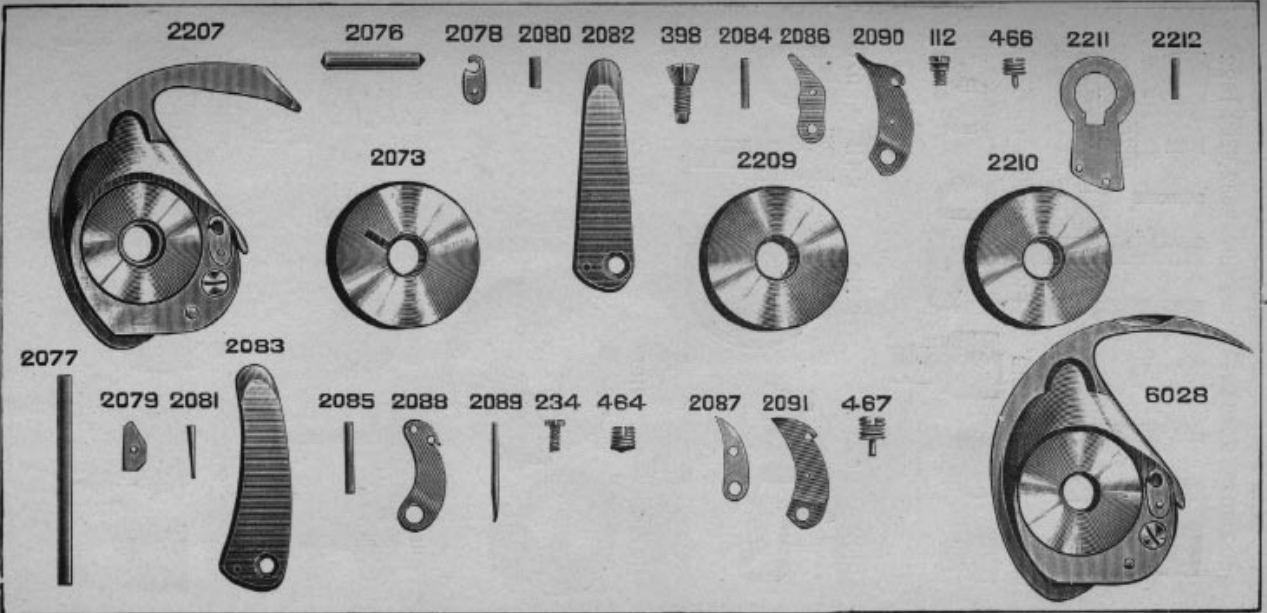

PLATE 217—FULL SIZE

PLATE 221—FULL SIZE

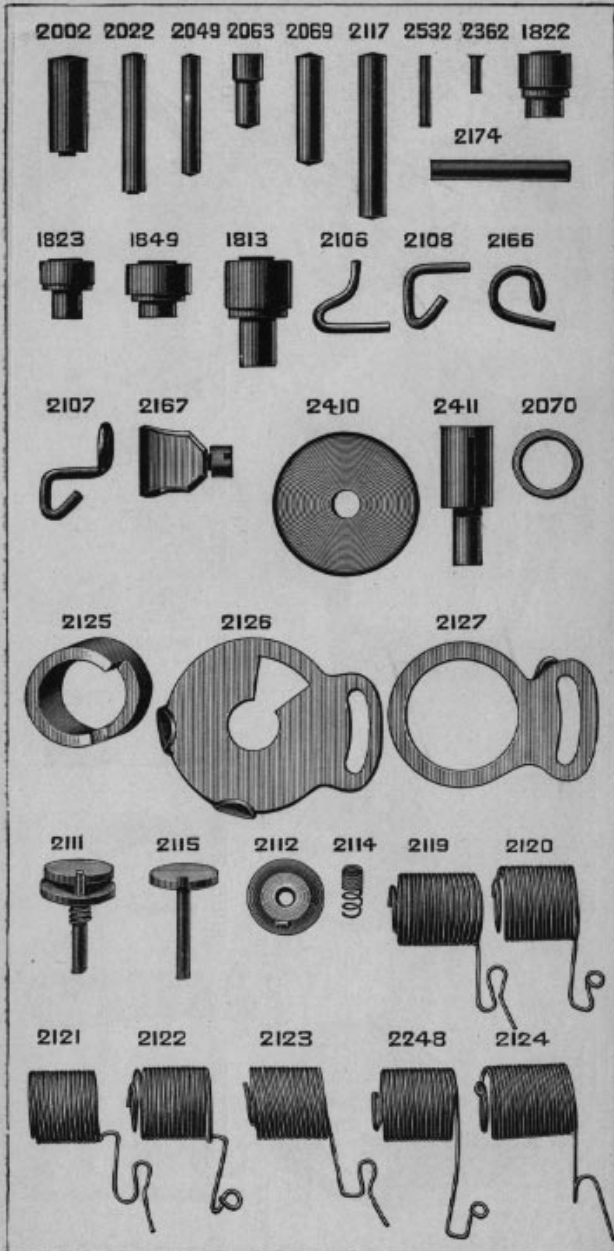

PLATE 231—FULL SIZE

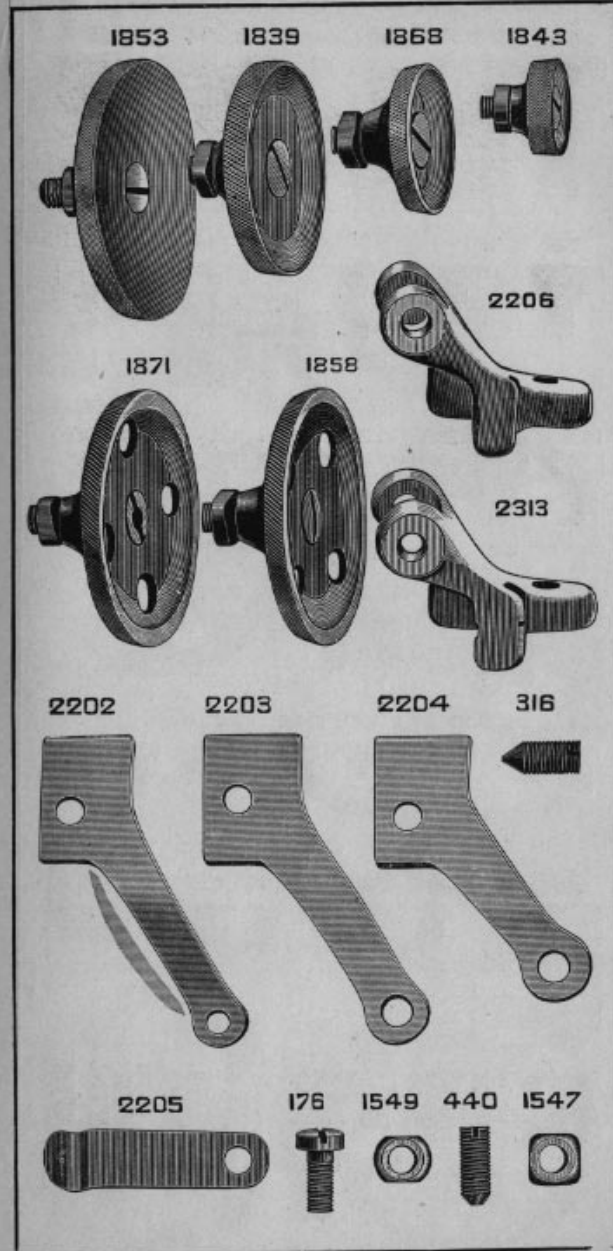

PLATE 237—FULL SIZE

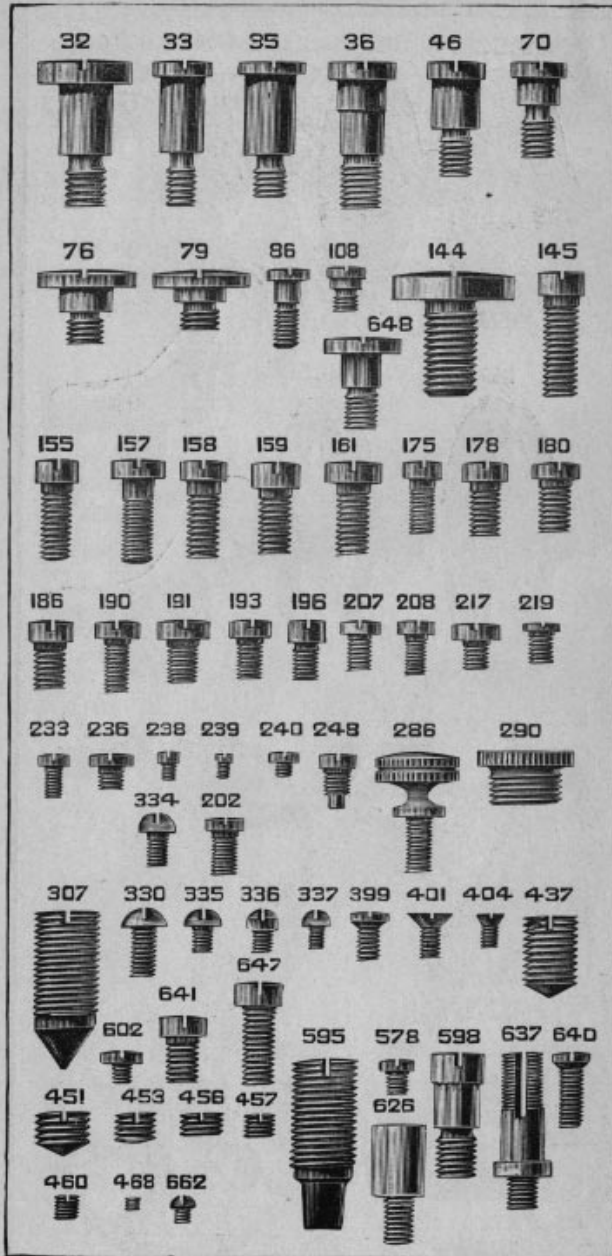

PLATE 256—ONE-FOURTH SIZE

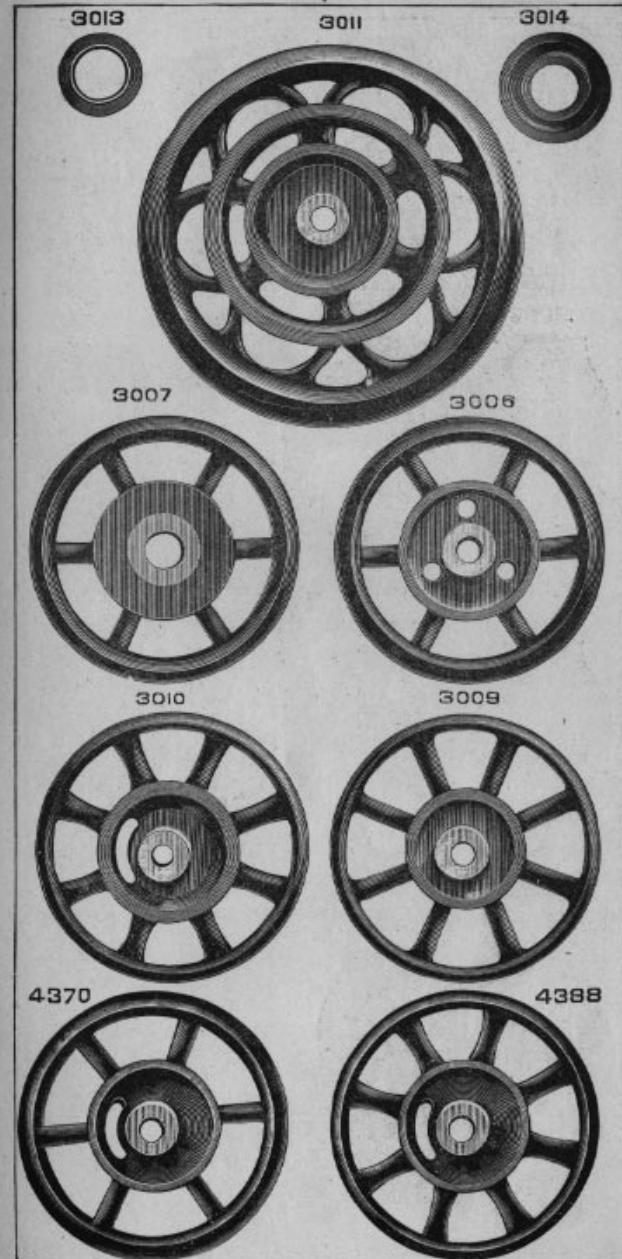

PLATE 297—FULL SIZE.

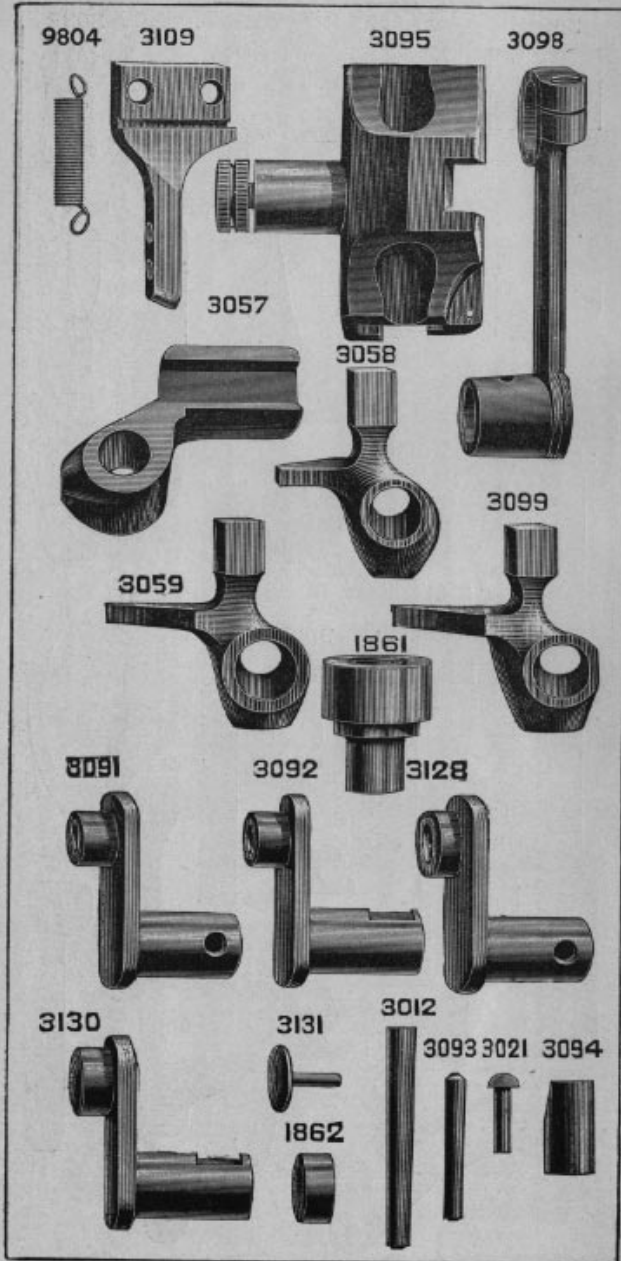

PLATE 301—ONE-HALF SIZE

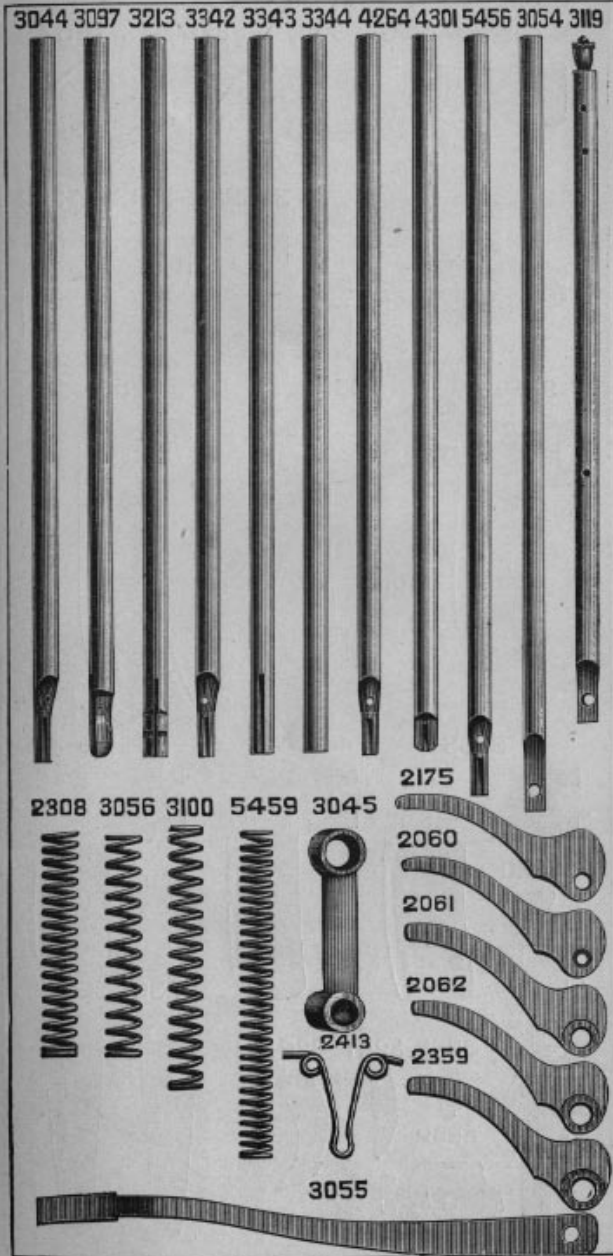

PLATE 302—FULL SIZE.



PLATE 303—FULL SIZE.

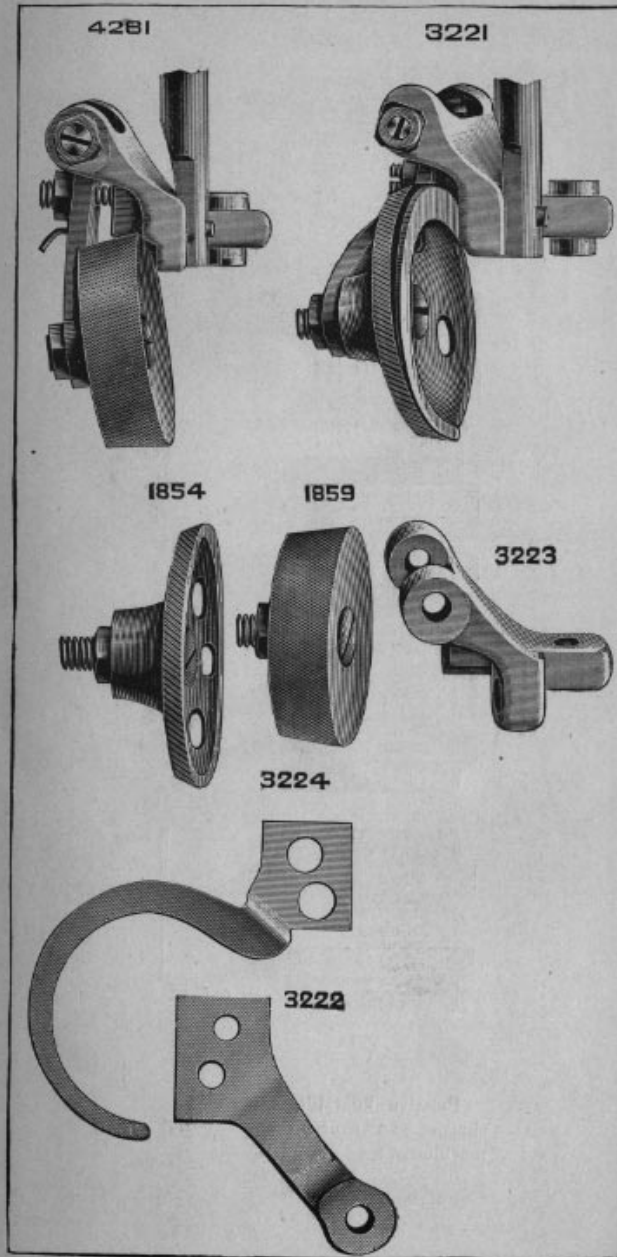
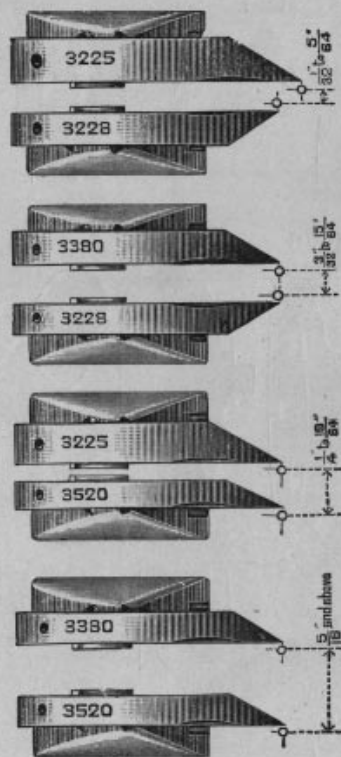

PLATE 304—FULL SIZE.



Relative POSITION and STYLE of shuttles in two needle and two shuttle machines.

PLATE 310—ONE-HALF SIZE.

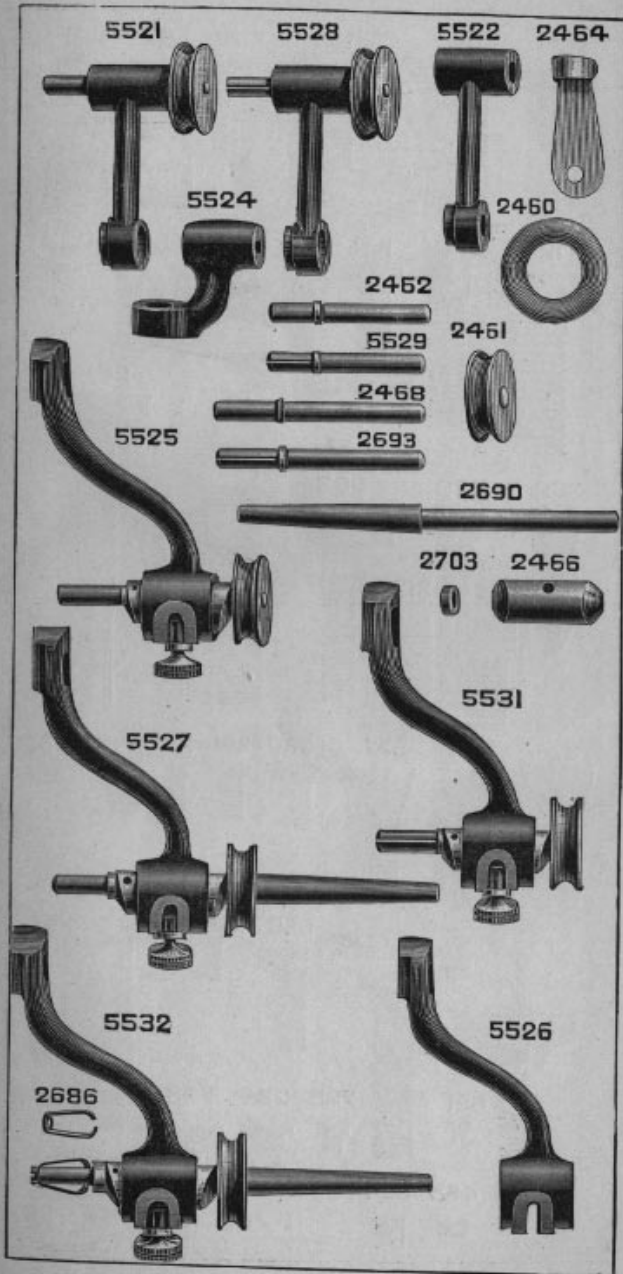

PLATE 312—FULL SIZE.

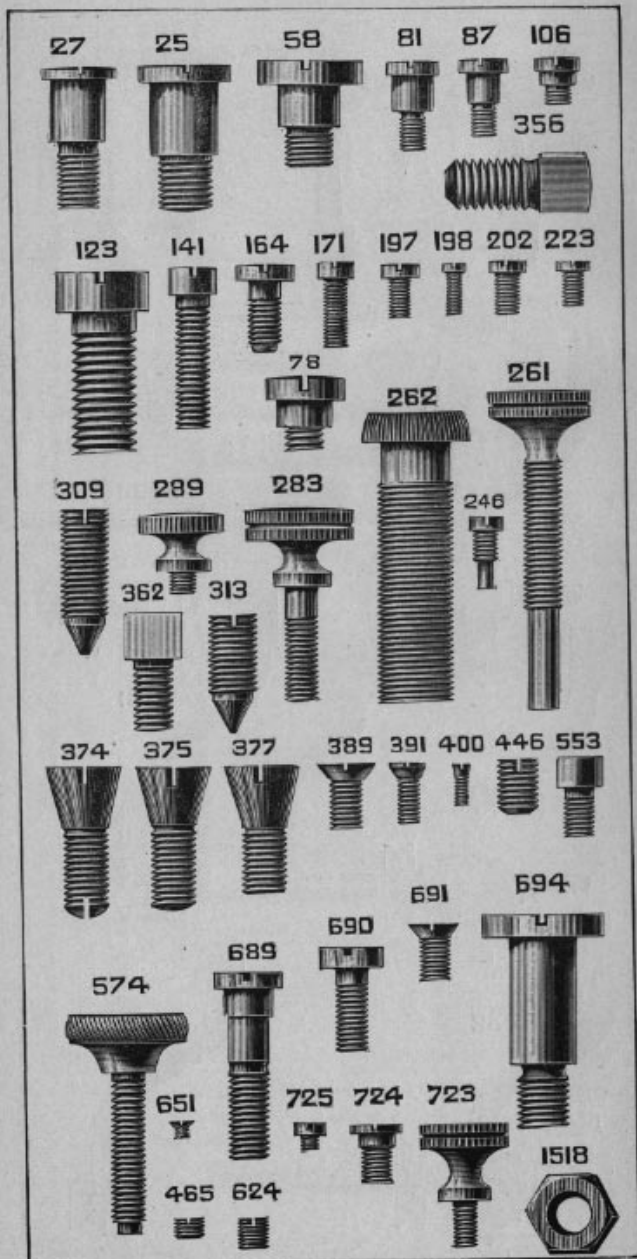

PLATE 364—ONE-FOURTH SIZE

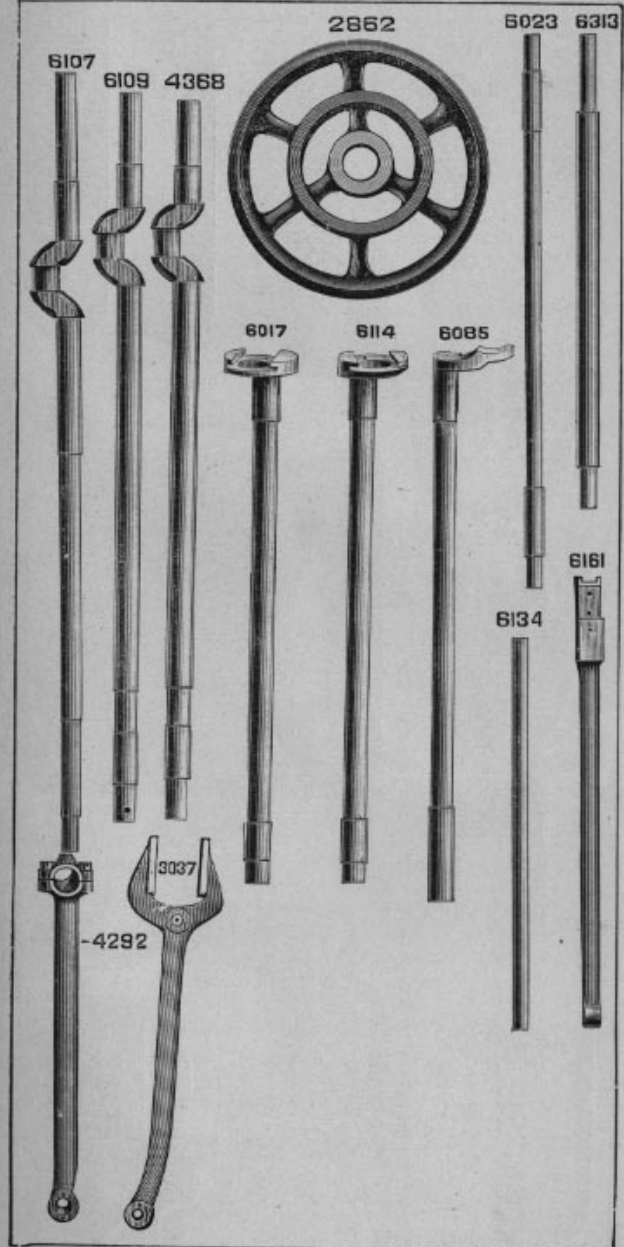

PLATE 365—ONE-FOURTH SIZE

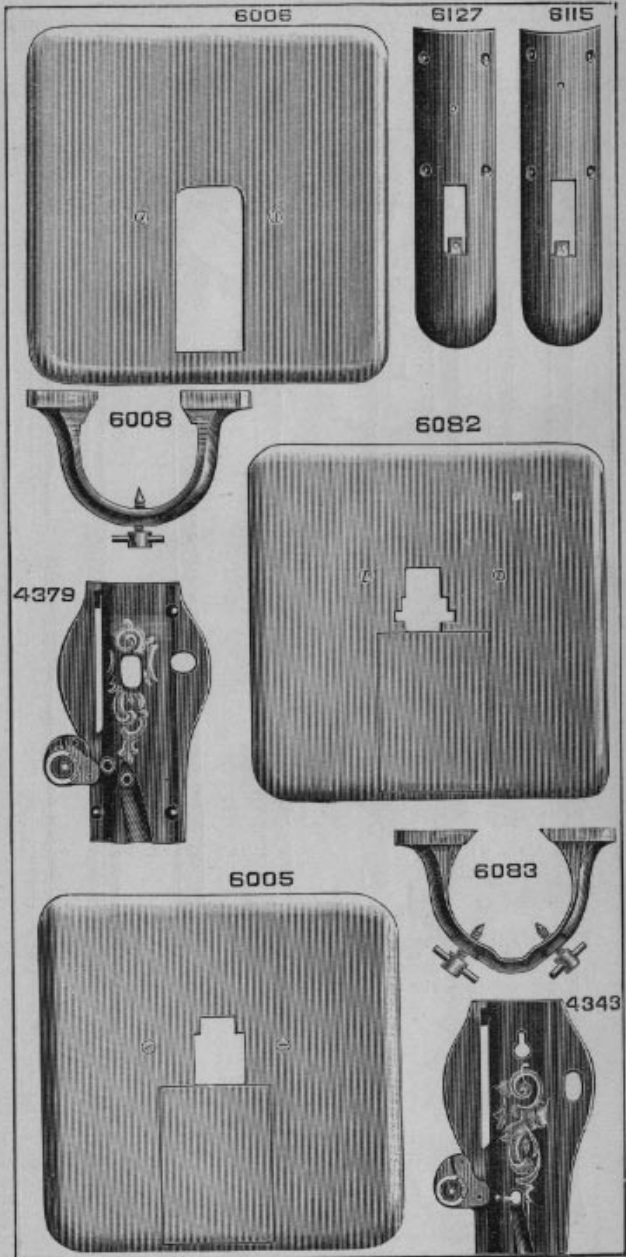

PLATE 366—ONE-HALF SIZE

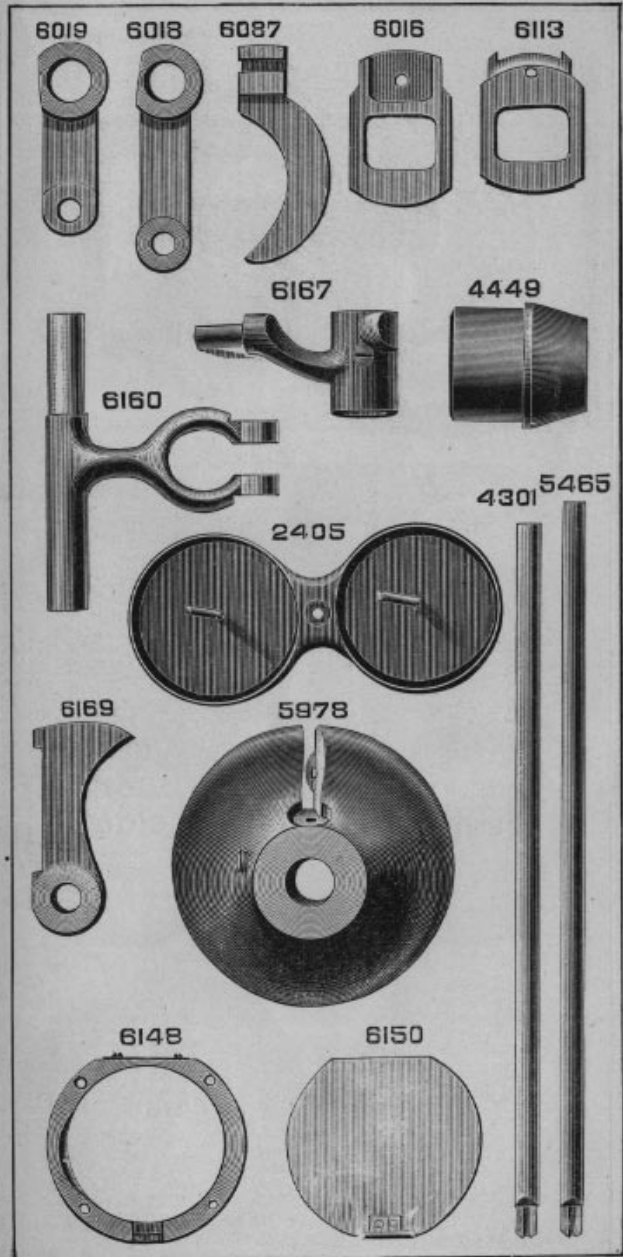

PLATE 367—ONE-HALF SIZE

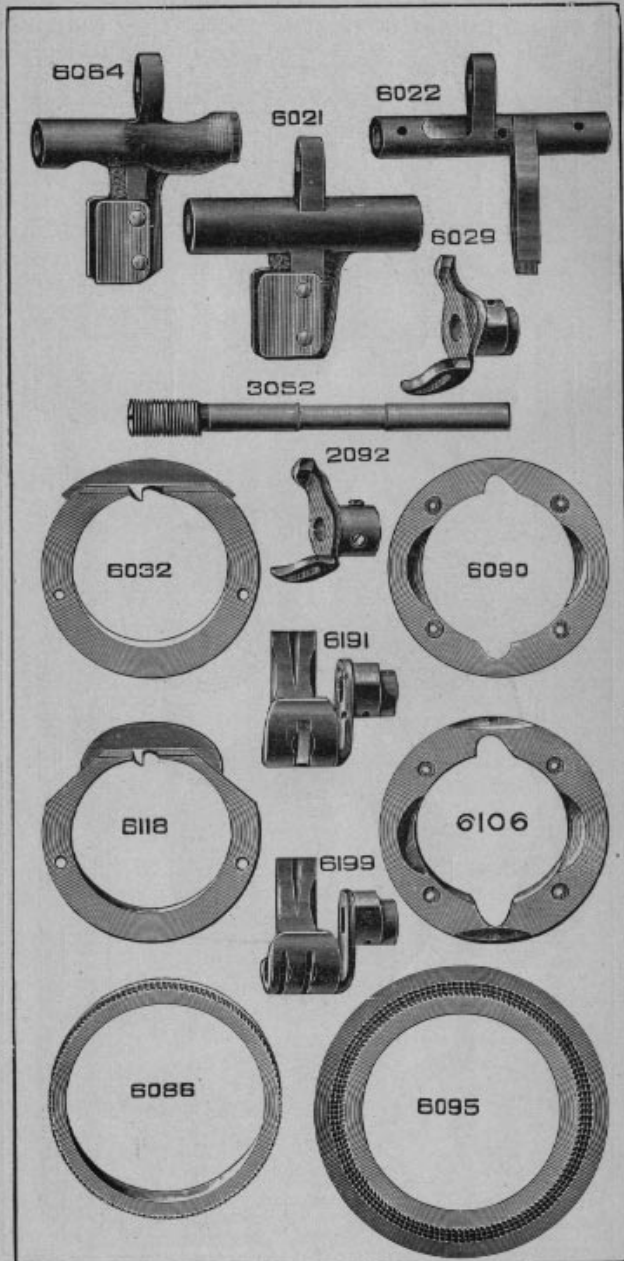

PLATE 368—ONE-HALF SIZE

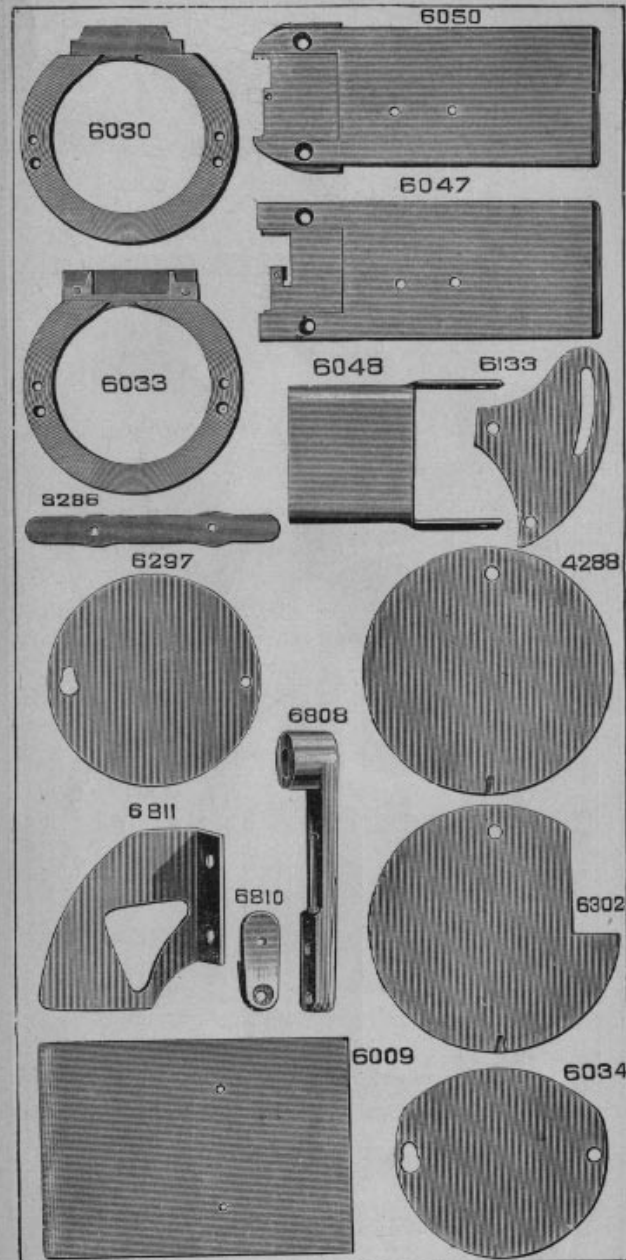

PLATE 369—ONE-HALF SIZE

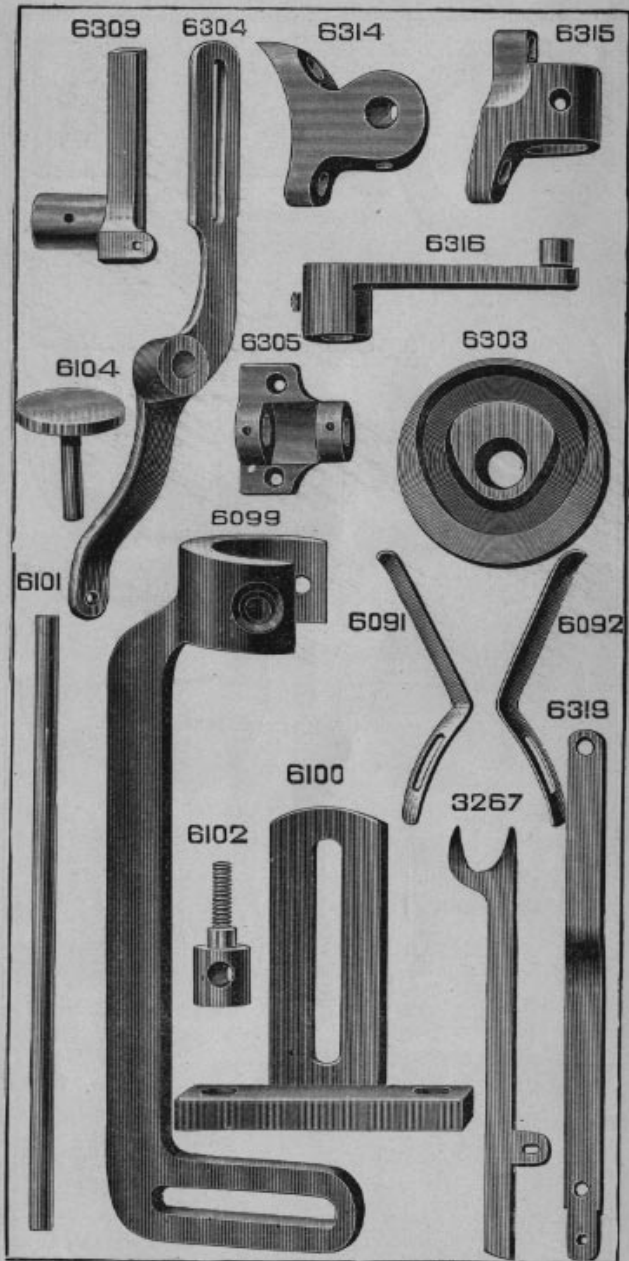

PLATE 370—ONE-HALF SIZE

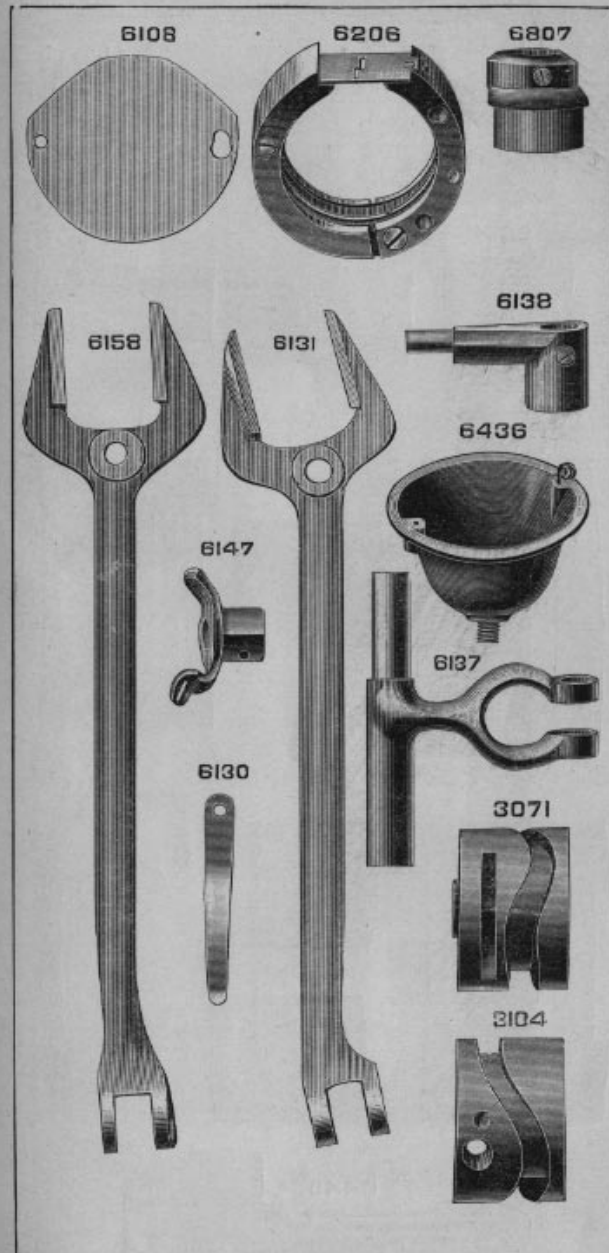

PLATE 373-FULL SIZE

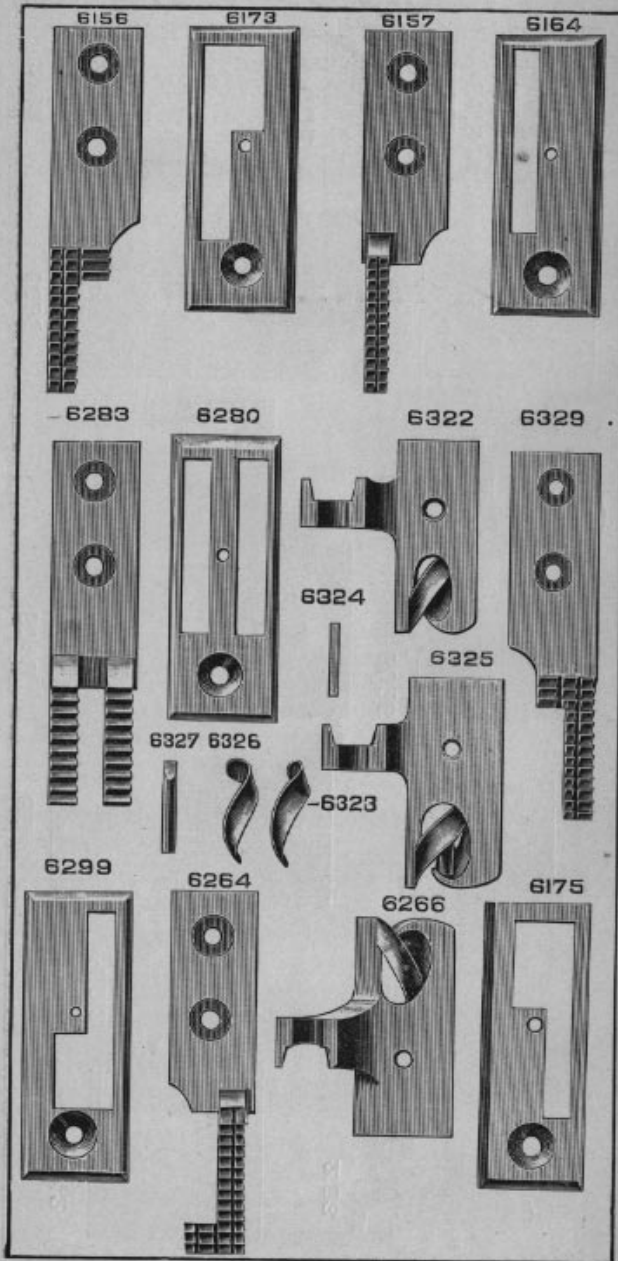

PLATE 374-FULL SIZE

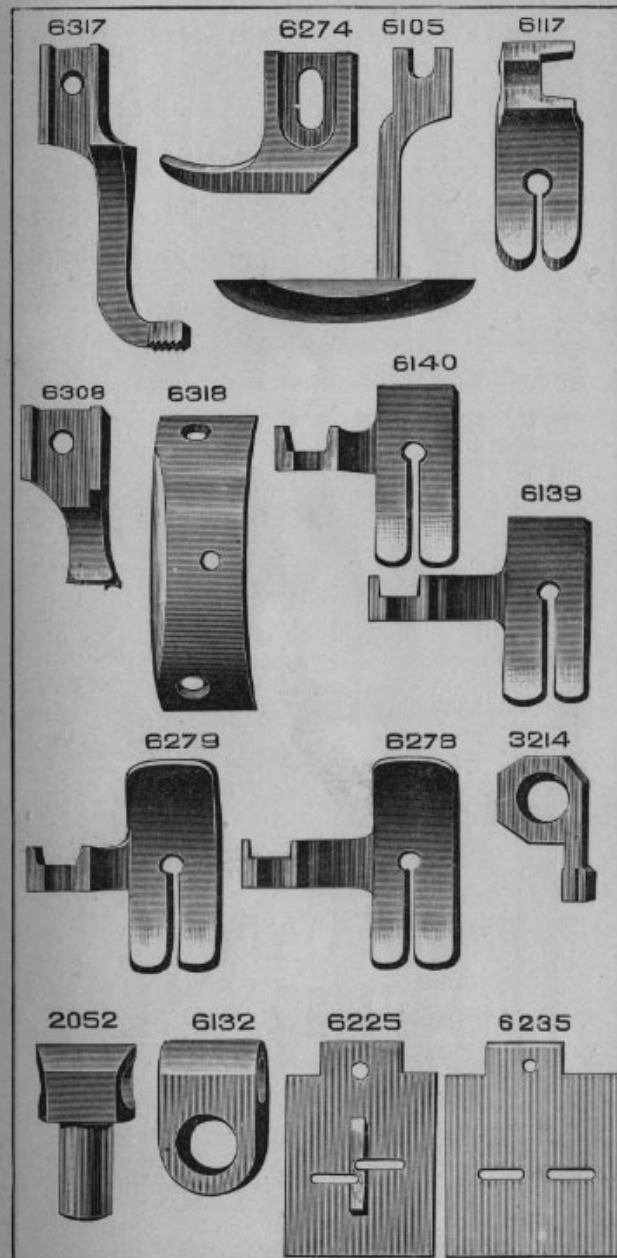

PLATE 375—FULL SIZE

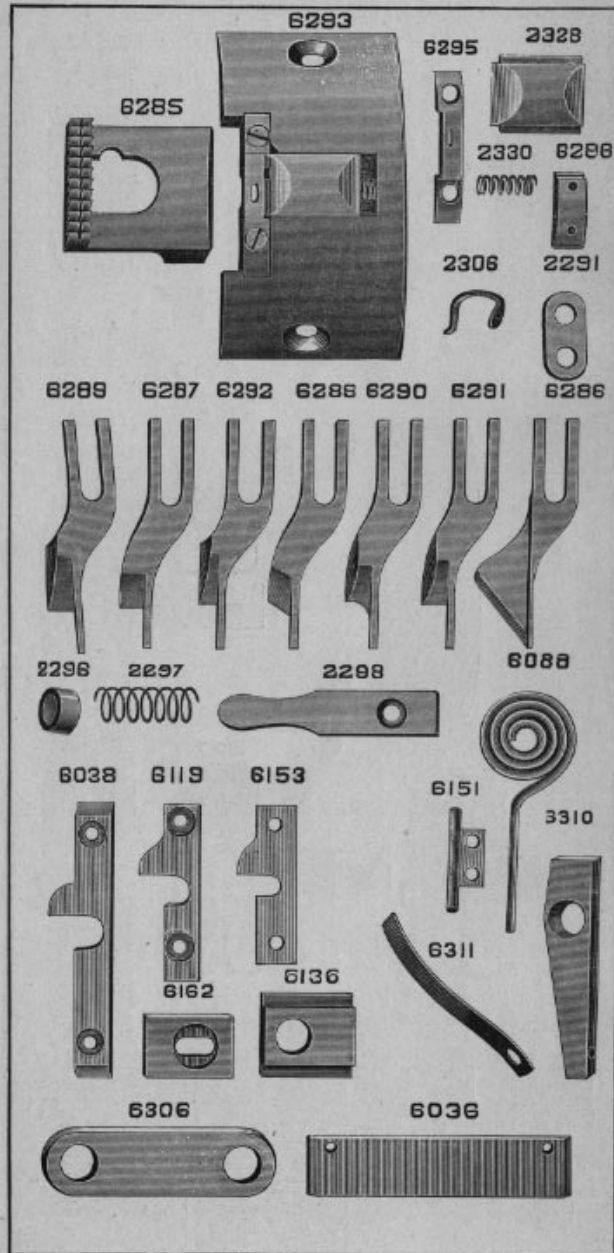

PLATE 376—FULL SIZE

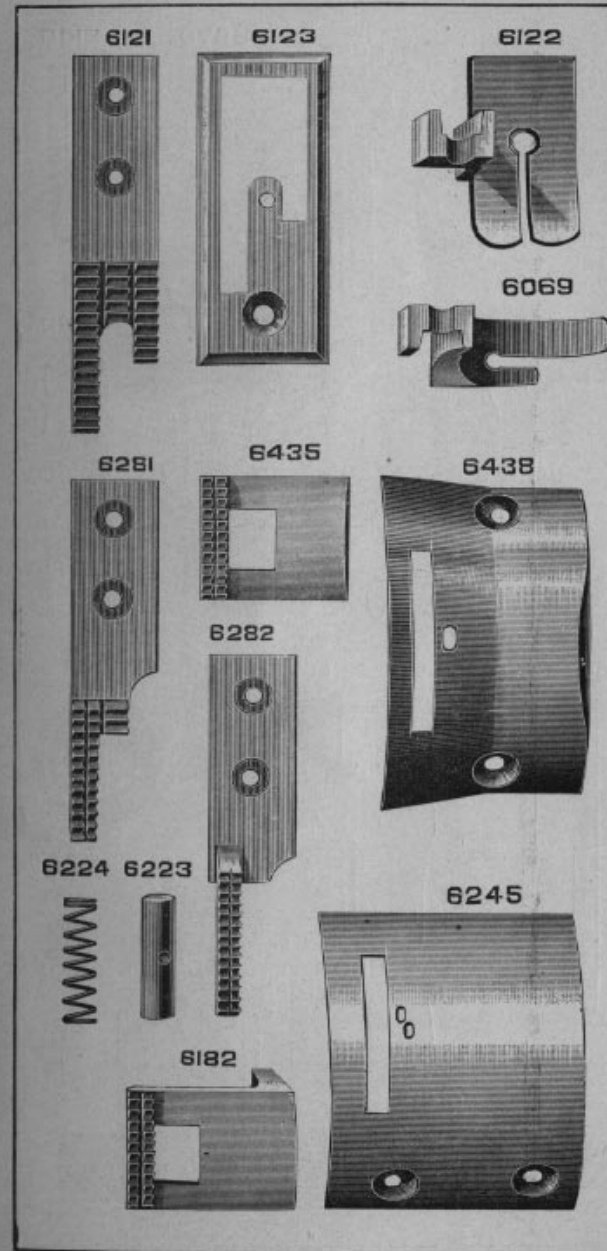

PLATE 377—FULL SIZE

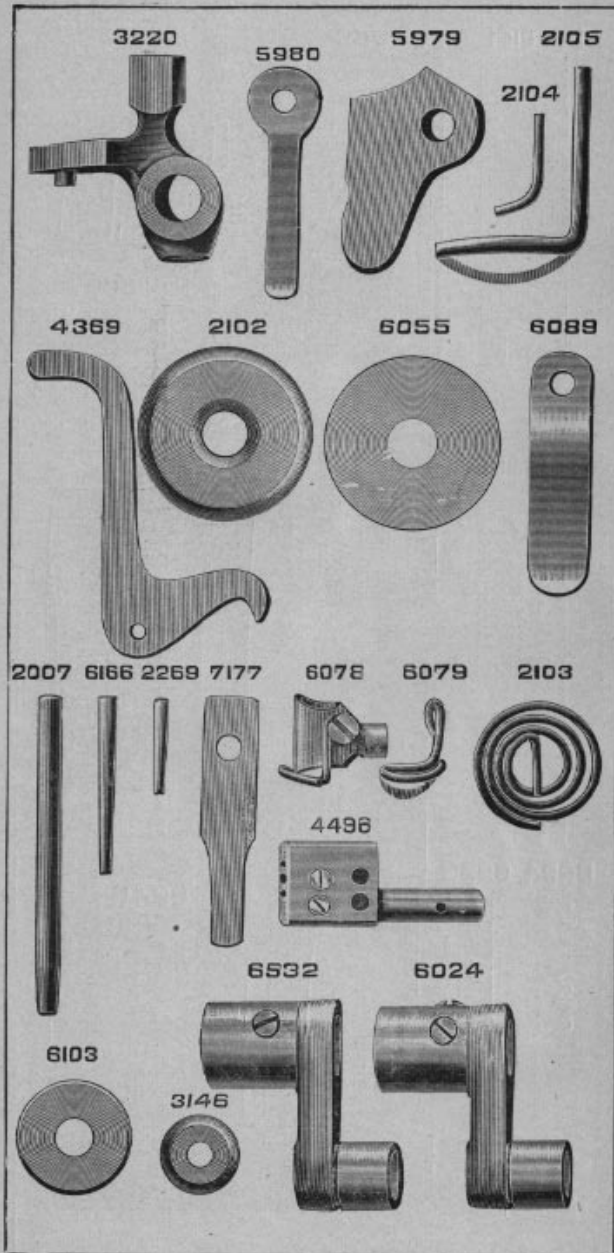

PLATE 378—FULL SIZE

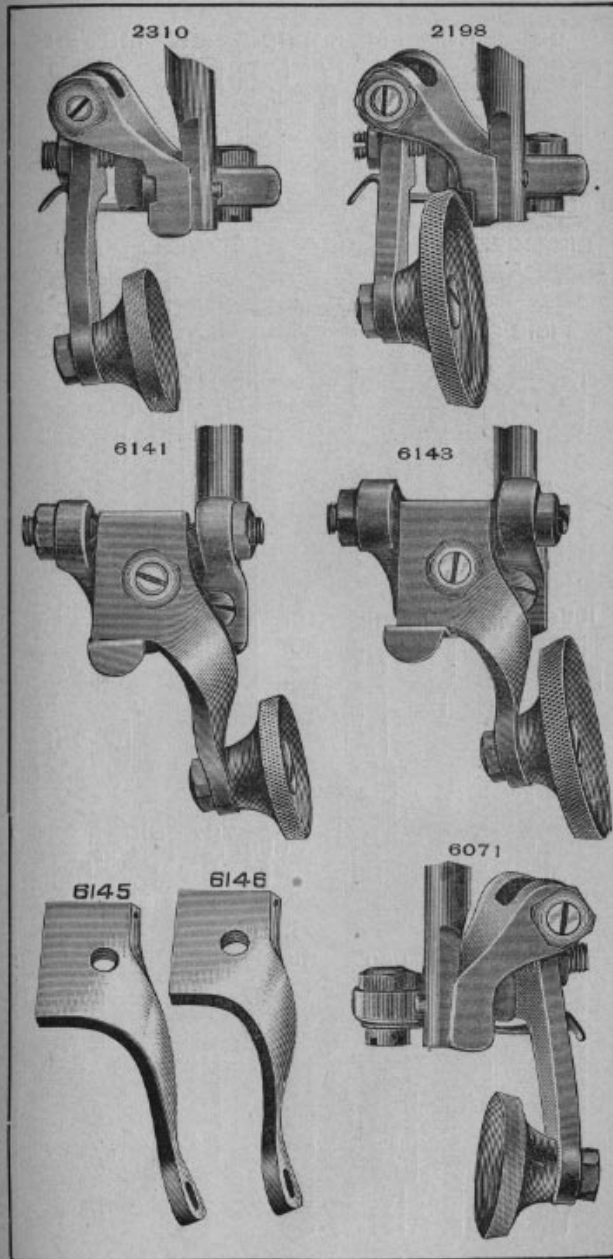

PLATE 379—FULL SIZE

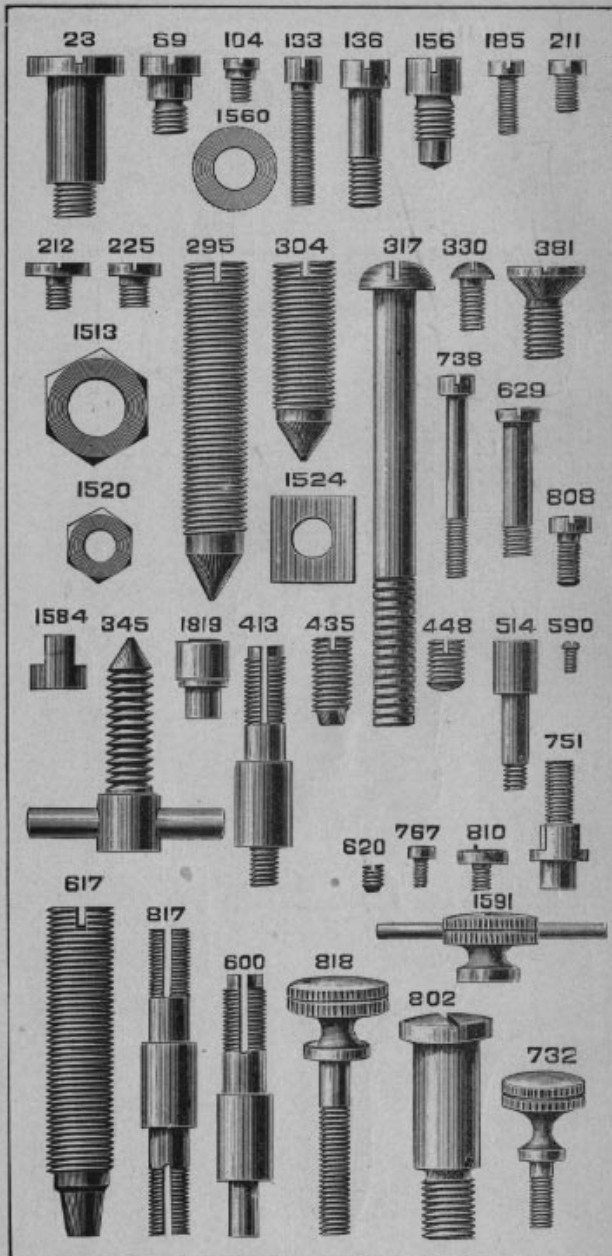
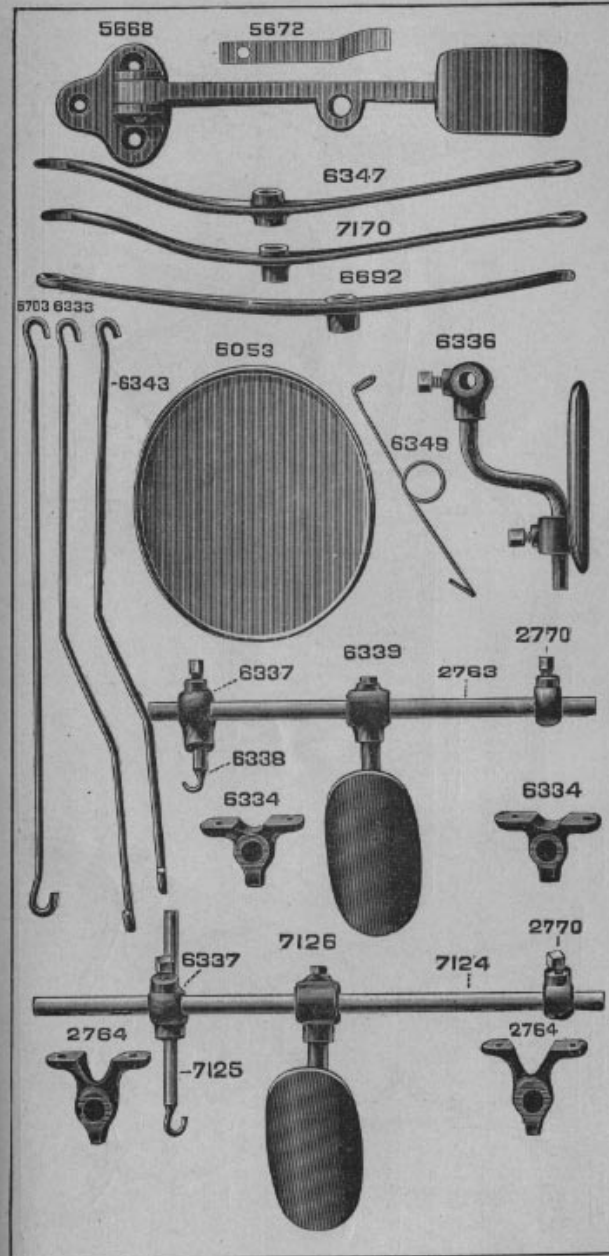

PLATE 380—ONE-FOURTH SIZE



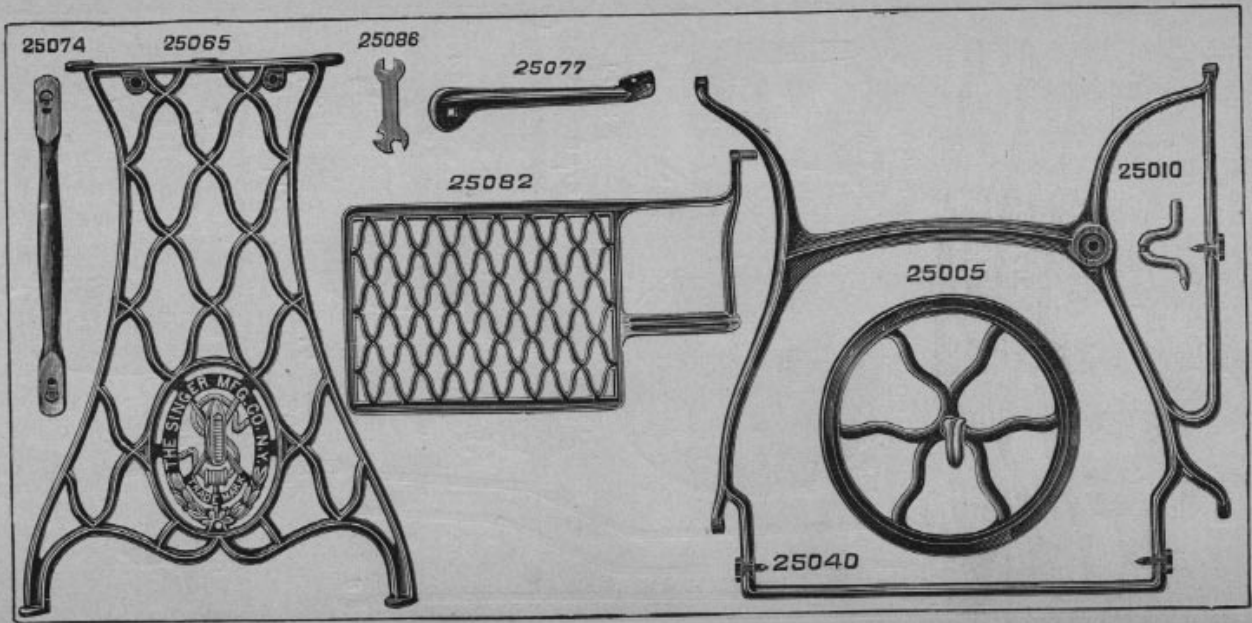

PLATE 381—ONE-EIGHTH SIZE